

SDC EMLock®

# 1580 Series

## 650lb Holding Force EMLocks



SDC's electromagnetic locks are suited for interior doors, perimeter exit doors and entrances that require failsafe emergency release capability. **The patented EMLock® design represents the pinnacle of magnetic lock evolution with modular assembly that makes them easy to stock, install, upgrade and maintain.** The housing design provides a superior appearance with a plated or anodized finish on all sides. The interlocking EZ mount assembly leaves hands free for wiring and securing of mounting screws. EMLocks® are UL listed and ANSI grade 1 compliant.

EMLocks® are compatible with any access control system and covered by a lifetime limited warranty.

**SDC's 1580 series locks provide 650 lbs of holding force** for traffic control and are adaptable to virtually any application when used in conjunction with SDC's vast offering of mounting brackets, kits and hardware.\*

\* See related products.



**1581V**



**1582V**

### MODELS

**1581** Single EMLock, 650lbs

**1582** Double EMLock, 650lbs

### STANDARD FEATURES

- Uniform design and installation
- Wire access chamber with terminal block
- Interlocking quick mount assembly
- Auto-sensing dual voltage
- Voltage and current spike protection
- Instant release anti-residual magnetism circuitry
- Captive lock mounting screws
- Self-drilling and tapping sheet metal screws
- 1½" machine screws included

### OPTIONAL FEATURES

- Door position status (DPS)
- Bond alert status (BAS)
- Anti-tamper status (ATS)
- Visual status indicator (LED)\*

\* Requires field installation and additional wiring.



## APPLICATIONS

### ALUMINUM FRAME / ALUMINUM GLASS DOOR

Utilize angle brackets for push-side mounting.\*

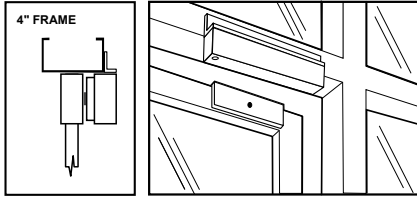

Single Swing Door Push-Side Mounting

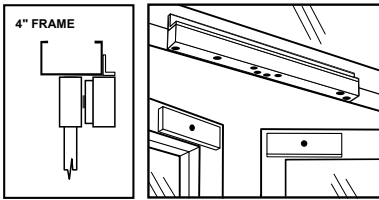

Double Swing Doors Push-Side Mounting

### HOLLOW METAL OR ALUMINUM FRAME / GLASS DOOR WITHOUT TOP RAIL

Utilize glass door mounting kits and angle brackets for push-side mounting.\*

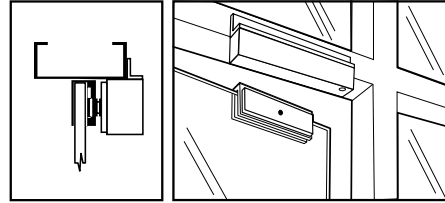

Single Swing Door Push-Side Mounting

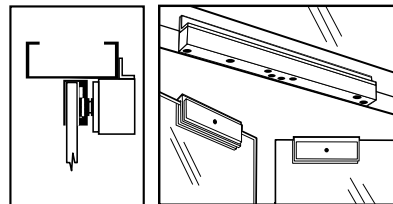

Double Swing Doors Push-Side Mounting

### HOLLOW METAL FRAME / WOOD OR HOLLOW METAL DOOR

No additional hardware required for push-side mounting. Utilize filler plate for smaller soffits.

Utilize top jamb mounting kits for pull-side mounting.\*

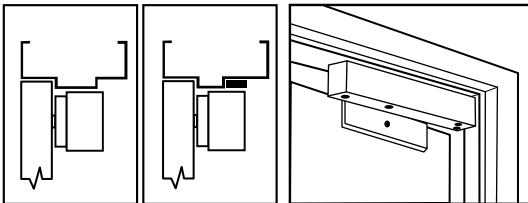

Single Swing Door Push-Side Mounting

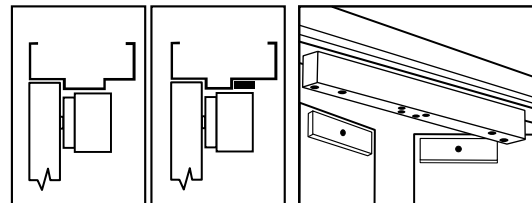

Double Swing Doors Push-Side Mounting

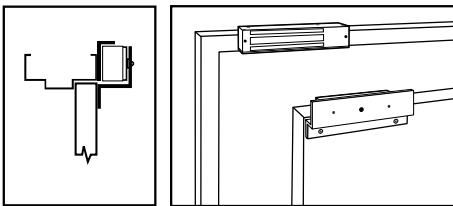

Single Swing Door Pull-Side Mounting

\* See related products to order AB angle brackets, HDB glass door mounting kits, TJ top jamb mounting kits and more optional mounting hardware.

## CROSS REFERENCE

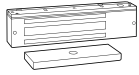

	1510	1570	1580	E1200	E600	E6200
<b>Maglock Type</b>	Standard	Standard	Standard	Standard	Standard	Standard
<b>Trademark</b>	EMLock®	EMLock®	EMLock®	Excel™	Excel™	-----
<b>Warranty</b>	Lifetime	Lifetime	Lifetime	5 Year	5 Year	5 Year
<b>Holding Force</b>	1,650 lbs	1,200 lbs	650 lbs	1,200 lbs	600 lbs	1,200 lbs
<b>Single</b>	1511	1571	1581	E1200	E600	E6200
<b>Double</b>	1512	1572	1582	-----	-----	-----
<b>Monitoring</b>	Optional or Field Upgrade Kits	Optional or Field Upgrade Kits	Optional	Standard	Standard	Standard

[CLICK TO VIEW](#)

[CLICK TO VIEW](#)

[CLICK TO VIEW](#)

[CLICK TO VIEW](#)

[CLICK TO VIEW](#)

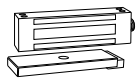

	350	1590	1575 / 1576	E300	EP17624
<b>Maglock Type</b>	Specialty	Specialty	Specialty	Specialty	Specialty
<b>Application</b>	Narrow	Sliding Doors	Outdoor Gates	Cabinets	Hazardous
<b>Weatherized</b>	-----	-----	Yes	-----	Explosion Proof
<b>Holding Force</b>	1,200 lbs	850 lbs	1,200 lbs	300 lbs	600 lbs
<b>Single</b>	350V	1591U	1575U, 1576U	E300	EP17624, EP17624TJ
<b>Double</b>	352V	-----	-----	-----	-----
<b>Monitoring</b>	Standard	Optional	Standard	Standard	Standard

[CLICK TO VIEW](#)

[CLICK TO VIEW](#)

[CLICK TO VIEW](#)

[CLICK TO VIEW](#)

[CLICK TO VIEW](#)

## SPECIFICATIONS

	1581	1582
<b>Housing</b>	Aluminum	Aluminum
<b>Door Type</b>	Swing, Single	Swing, Double
<b>Holding Force</b>	650 lbs	650 lbs
<b>Dimensions</b>	8¾" x 2½" x 1¼" Housing 6¾" x 1½" x ½" Armature	17½" x 2½" x 1¼" Housing 6¾" x 1½" x ½" Armature
<b>Weight</b>	5 lbs	8 lbs
<b>Input</b>	12/24 VDC ± 10% Auto-sensing	12/24 VDC ± 10% Auto-sensing
<b>Current Draw</b>	220 mA @ 24 VDC 440 mA @ 12 VDC	440 mA @ 24 VDC 880 mA @ 12 VDC
<b>Door Position Status (DPS)</b>	SPDT 250 mA @ 30 VDC Resistive	SPDT 250 mA @ 30 VDC Resistive
<b>Bond Alert Status (BAS)</b>	SPST 250 mA @ 30 VDC Resistive	SPST 250 mA @ 30 VDC Resistive
<b>Anti-Tamper Status (ATS)</b>	SPDT 5 Amp @ 125 VAC Resistive	SPDT 5 Amp @ 125 VAC Resistive

## CERTIFICATIONS

UL 294 Access Control System Units  
 UL 10B Fire Tests of Door Assemblies  
 UL 10C Positive Pressure Fire Tests of Door Assemblies  
 ULC-S104 Standard Method for Fire Tests of Door Assemblies  
 ULC-S533 Egress Door Securing and Releasing Devices

Uniform Building Code Standard 7-2 Fire Test of Door Assemblies (1997)  
 ANSI/BHMA A156.23 Grade 1  
 CSFM Listed 3774-0324:100  
 MEA City of New York 61-95-E

## HOW TO ORDER

### FOLLOW STEPS FOR ORDERING

 Designates optional step

#### 1| SPECIFY MODEL

- 1581** Single EMLock, 650lbs
- 1582** Double EMLock, 650lbs

#### 2| SPECIFY FINISH

- V** 628 Dull Aluminum  Standard
- Y** 335 Dull Black
- C** 605 Bright Brass
- X** 710 Dark Bronze
- Q** 626 Dull Chrome
- P** 625 Bright Chrome

#### 3| SPECIFY OPTIONS

- D** Door Position Status (DPS)
- B** Bond Alert Status (BAS)
- A** Anti-Tamper Status (ATS)
- L\*** Visual Status Indicator (LED)

\* Requires field installation and additional wiring.

STEP NUMBER:	1	2	3
ORDERING EXAMPLE:	<b>1581</b>	<b>V</b>	<b>DB</b>



## RELATED PRODUCTS\*

### DELAYED EGRESS LOCKS.

Stop theft, control pedestrians in public facilities and airports, control wandering patients, and guard against infant abduction.



[CLICK TO VIEW](#)

### FILLER PLATES

For extension of the stop to provide a proper mounting surface on the underside of the header. See figure 1B.

**FP01V** 1/8" x 1 1/4" x 8 3/4"

**FP02V** 1/4" x 1 1/4" x 8 3/4"

**FP03V** 3/8" x 1 1/4" x 8 3/4"

**FP04V** 1/2" x 1 1/4" x 8 3/4"

**FP05V** 5/8" x 1 1/4" x 8 3/4"

**FP30V** 1/8" x 1 1/4" x 17 1/2"

**FP31V** 1/4" x 1 1/4" x 17 1/2"

**FP32V** 3/8" x 1 1/4" x 17 1/2"

**FP33V** 1/2" x 1 1/4" x 17 1/2"

**FP34V** 5/8" x 1 1/4" x 17 1/2"

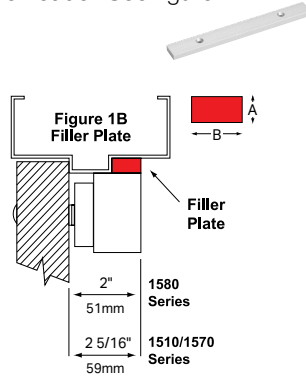

### REUSABLE DRILL FIXTURES

**1581-DF** Heavy Duty Drill Fixture for 1581 EMLock Installations



### ANGLE BRACKETS

Used as extension on shallow door frames to provide adequate mounting surface. See figure 1C.

**AB01V** 1" x 1" x 8 3/4"

**AB02V** 1" x 1 1/2" x 8 3/4"

**AB03V** 1 1/2" x 1 1/2" x 8 3/4"

**AB04V** 2" x 1 1/2" x 8 3/4"

**AB30V** 1" x 1" x 17 1/2"

**AB31V** 1" x 1 1/2" x 17 1/2"

**AB32V** 1 1/2" x 1 1/2" x 17 1/2"

**AB33V** 2" x 1 1/2" x 17 1/2"

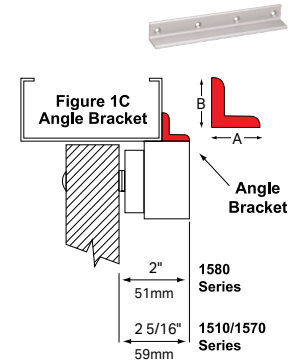

### TOP JAMB MOUNTING KITS

Accommodate the installation of a standard magnetic lock to the pull-side of hollow metal door openings.

**TJ81V** Top Jamb Kit, Single

**TJ82V** Top Jamb Kit, Double



### GLASS DOOR MOUNTING KITS

Accommodate the installation of the lock armature assemblies to glass doors without top rails. Field adjustable for 3/8", 1/2" and 5/8" glass herculite doors.

**HDB1V** 2 1/2" x 1 1/2" x 8 1/2"

**HDB2V** 2 1/2" x 1 1/2" x 8 1/2", Qty 2



### SPACER BRACKETS

For aluminum frames with blade stop and concrete filled hollow metal frames. SDC's spacer brackets lower the lock below blade stop to ensure proper function in aluminum frames and provides multiple points for concealed wire entry in concrete filled hollow door frames.

**UF81V** 1/2" x 1 1/2" x 8 3/4"

**UF82V** 1/2" x 1 1/2" x 17 1/2"



\* Consult factory for special finishes.

## COMPONENT CONSIDERATIONS

### EMERGENCY DOOR RELEASES

[CLICK TO VIEW](#)



SDC's line of emergency door releases (EDR's) are designed to provide a physical method of unlocking an electronic lock in the event of an emergency and may influence the approval of an electric locking system. EDR's are usually fitted to emergency exit doorways in higher security areas. Our EDR's can initiate the release of an individual door or all doors on the same circuit and provide an auxiliary contact remote monitoring, CCTV activation or alarm activation.

### KEYPADS & READERS

[CLICK TO VIEW](#)



SDC has a variety of digital keypad and proximity card access control system equipment to meet any need. SDC's keypads and readers are engineered to provide real-world door control of a single opening up to 100 doors, such as indoor, outdoor and PC-based systems, while ensuring fire and life safety code compliance along with superior expandability and flexibility in authorization identification, authentication, access approval and accountability of entities through login credentials.

### EXIT SWITCHES & SENSORS

[CLICK TO VIEW](#)



SDC offers a variety of exit button and push button styles and contact configurations to fit several request-to-exit application needs. Additionally, SDC's wave-to-open switches and motion sensors provide hands free compliance and convenience for touchless applications using proven infrared detection technology. A simple wave of the hand in front of our touchless switch models activates the switch to control electric locks/strikes, magnetic locks or automatic door operators for entry or egress.

### DOOR PROP ALARMS & ANNUNCIATORS

[CLICK TO VIEW](#)



Multi-mode annunciators, like SDC's EA series door prop alarm, EA100 and 400 series LEDs, sirens, buzzers and speakers come in a variety of door, frame, wall, ceiling or single and double gang box configurations to provide the ultimate in door status indication, access control system compatibility and control. SDC door prop alarms are compatible with all access control systems but can also function as a standalone solution.

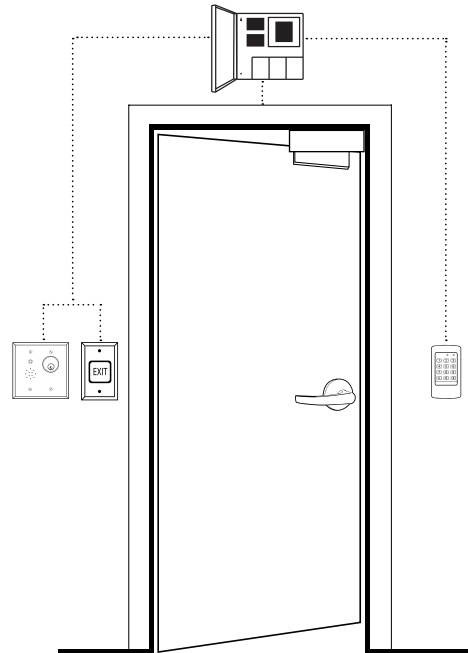

### POWER CONTROLLERS

[CLICK TO VIEW](#)



SDC access control power supplies have been developed specifically to support access controls and electric locking hardware. They are UL listed and provide filtered and regulated linear DC power, with optional control logic, component interface, alarm interface and battery back-up to meet the requirements of single and multiple access-controlled openings. The circuitry design is ideal for the inductive loads generated by access control hardware for high performance and longevity.

### DOOR CONTROLS & BACKUP BATTERIES

[CLICK TO VIEW](#)



SDC's door control relay modules ensure compatibility of access hardware components and simplify system installation and troubleshooting. Different modules may be specified for one power supply. The isolated relay design allows trigger signals over small gauge cable runs of 22 gauge wire up to 1,000 feet from the trigger device to the module. SDC's engineered system design services are available when you purchase SDC locks, control modules and power controllers for your door opening applications.