

SDC EMLock®

1510 Series

1650lb Holding Force EMLocks



SDC's electromagnetic locks are suited for interior doors, perimeter exit doors and entrances that require failsafe emergency release capability. **The patented EMLock® design represents the pinnacle of magnetic lock evolution with modular assembly that makes them easy to stock, install, upgrade and maintain.** The housing design provides a superior appearance with a plated or anodized finish on all sides. The interlocking EZ mount assembly leaves hands free for wiring and securing of mounting screws. EMLocks® are UL listed and ANSI grade 1 compliant.

EMLocks® are compatible with any access control system and covered by a lifetime limited warranty.

SDC's 1510 series locks provide 1,650 lbs of holding force for increased security and are adaptable to virtually any application when used in conjunction with SDC's vast offering of mounting brackets, kits and hardware.*

* See related products.



1511V



1512V

MODELS

1511 Single EMLock, 1650lbs

1512 Double EMLock, 1650lbs

STANDARD FEATURES

- Uniform design and installation
- Wire access chamber with terminal block
- Interlocking quick mount assembly
- Auto-sensing dual voltage
- Voltage and current spike protection
- Instant release anti-residual magnetism circuitry
- Captive lock mounting screws
- Self-drilling and tapping sheet metal screws
- 1/32" machine screws included
- Field upgradeable without removing from the frame*

* See related products for EZ field upgrade kits.

OPTIONAL FEATURES

- Door position status (DPS)
- Bond alert status (BAS)
- Anti-tamper status (ATS)
- Relock time delay (RTD)
- Visual status indicator (LED)*

* Requires field installation and additional wiring.



APPLICATIONS

ALUMINUM FRAME / ALUMINUM GLASS DOOR

Utilize angle brackets for push-side mounting.*

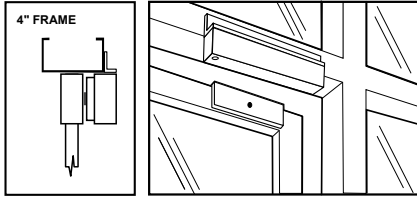

Single Swing Door Push-Side Mounting

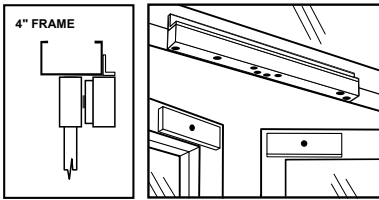

Double Swing Doors Push-Side Mounting

HOLLOW METAL OR ALUMINUM FRAME / GLASS DOOR WITHOUT TOP RAIL

Utilize glass door mounting kits and angle brackets for push-side mounting.*

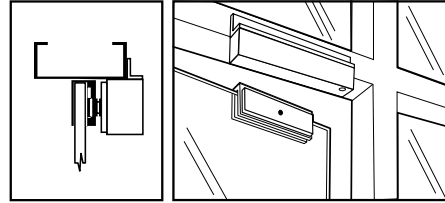

Single Swing Door Push-Side Mounting

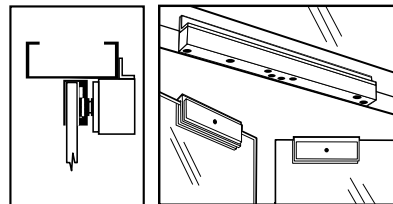

Double Swing Doors Push-Side Mounting

HOLLOW METAL FRAME / WOOD OR HOLLOW METAL DOOR

No additional hardware required for push-side mounting. Utilize filler plate for smaller soffits.

Utilize top jamb mounting kits for pull-side mounting.*

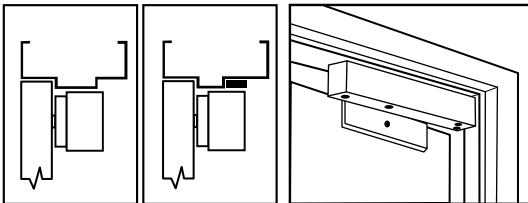

Single Swing Door Push-Side Mounting

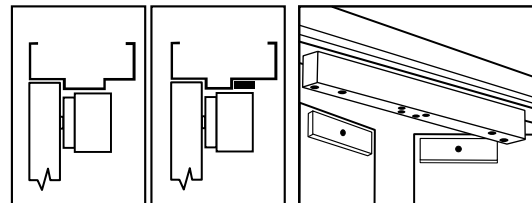

Double Swing Doors Push-Side Mounting

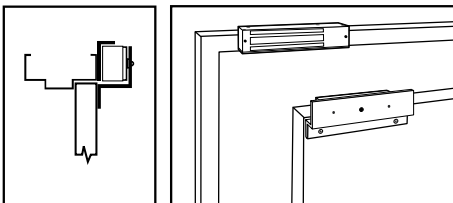

Single Swing Door Pull-Side Mounting

* See related products to order AB angle brackets, HDB glass door mounting kits, TJ top jamb mounting kits and more optional mounting hardware.

CROSS REFERENCE

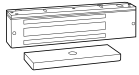

	1510	1570	1580	E1200	E600	E6200
Maglock Type	Standard	Standard	Standard	Standard	Standard	Standard
Trademark	EMLock®	EMLock®	EMLock®	Excel™	Excel™	-----
Warranty	Lifetime	Lifetime	Lifetime	5 Year	5 Year	5 Year
Holding Force	1,650 lbs	1,200 lbs	650 lbs	1,200 lbs	600 lbs	1,200 lbs
Single	1511	1571	1581	E1200	E600	E6200
Double	1512	1572	1582	-----	-----	-----
Monitoring	Optional or Field Upgrade Kits	Optional or Field Upgrade Kits	Optional	Standard	Standard	Standard

[CLICK TO VIEW](#)

[CLICK TO VIEW](#)

[CLICK TO VIEW](#)

[CLICK TO VIEW](#)

[CLICK TO VIEW](#)

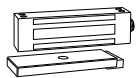

	350	1590	1575 / 1576	E300	EP17624
Maglock Type	Specialty	Specialty	Specialty	Specialty	Specialty
Application	Narrow	Sliding Doors	Outdoor Gates	Cabinets	Hazardous
Weatherized	-----	-----	Yes	-----	Explosion Proof
Holding Force	1,200 lbs	850 lbs	1,200 lbs	300 lbs	600 lbs
Single	350V	1591U	1575U, 1576U	E300	EP17624, EP17624TJ
Double	352V	-----	-----	-----	-----
Monitoring	Standard	Optional	Standard	Standard	Standard

[CLICK TO VIEW](#)

[CLICK TO VIEW](#)

[CLICK TO VIEW](#)

[CLICK TO VIEW](#)

[CLICK TO VIEW](#)

SPECIFICATIONS

	1511	1512
Housing	Aluminum	Aluminum
Door Type	Swing, Single	Swing, Double
Holding Force	1,650 lbs	1,650 lbs
Dimensions	11" x 27/8" x 1 1/8" Housing 7 3/8" x 2 3/8" x 5/8" Armature	22" x 27/8" x 1 1/8" Housing 7 3/8" x 2 3/8" x 5/8" Armature
Weight	11 lbs	27 lbs
Input	12/24 VDC ± 10% Auto-sensing	12/24 VDC ± 10% Auto-sensing
Current Draw	350 mA @ 24 VDC 670 mA @ 12 VDC	700 mA @ 24 VDC 1.34 Amps @ 12 VDC
Door Position Status (DPS)	SPDT	SPDT
Bond Alert Status (BAS)	250 mA @ 30 VDC Resistive	250 mA @ 30 VDC Resistive
Anti-Tamper Status (ATS)	SPDT 5 Amp @ 125 VAC Resistive	SPDT 5 Amp @ 125 VAC Resistive
Relock Time Delay (RTD)	Electronic Timer, Adjustable (1-30 seconds)	Electronic Timer, Adjustable (1-30 seconds)

CERTIFICATIONS

UL 294 Access Control System Units
 UL 1034 Burglary-Resistant Electric Locking Mechanisms
 UL 10B Fire Tests of Door Assemblies
 UL 10C Positive Pressure Fire Tests of Door Assemblies
 ULC-S104 Standard Method for Fire Tests of Door Assemblies

ULC-S533 Egress Door Securing and Releasing Devices
 Uniform Building Code Standard 7-2 Fire Test of Door Assemblies (1997)
 ANSI/BHMA A156.23 Grade 1
 CSFM Listed 3774-0324:100
 MEA City of New York 61-95-E

HOW TO ORDER

FOLLOW STEPS FOR ORDERING

 Designates optional step

1| SPECIFY MODEL

- 1511** Single EMLock, 1650lbs
- 1512** Double EMLock, 1650lbs

2| SPECIFY FINISH

- V** 628 Dull Aluminum  Standard
- Y** 335 Dull Black
- C** 605 Bright Brass
- X** 710 Dark Bronze
- Q** 626 Dull Chrome
- P** 625 Bright Chrome

3| SPECIFY OPTIONS

- D** Door Position Status (DPS)
- B** Bond Alert Status (BAS)
- A** Anti-Tamper Status (ATS)
- T** Relock Time Delay (RTD)
- L*** Visual Status Indicator (LED)

* Requires field installation and additional wiring.

STEP NUMBER:	1	2	3
ORDERING EXAMPLE:	1511	V	DB

RELATED PRODUCTS

VERTICAL HOUSING EMLOCK PACKAGES

By distributing the holding force at the top and bottom of the door, vertically housed EMLocks installed in the side jamb of an opening significantly enhance security while maintaining architectural aesthetics.

1512VV82* Vertical Housing for Standard 84" Openings, EMLocks Factory Installed, 3300lbs, 628 Finish

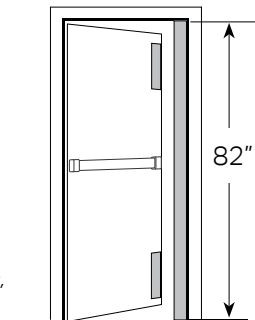

* Consult factory for special finishes, lengths or monitoring options.

FIELD UPGRADE KITS

No need to ever remove a lock from the frame to upgrade or exchange internal components. Field upgrade kits can be installed by distributors, technicians and maintenance staff.

EZ-D-10* Door Position Status (DPS) Kit

EZ-A Anti-Tamper Status (ATS) Kit

EZ-T-10 Relock Time Delay (RTD) Kit

* Order two for double EMLock applications.

DELAYED EGRESS LOCKS.

Stop theft, control pedestrians in public facilities and airports, control wandering patients, and guard against infant abduction.



[CLICK TO VIEW](#)

RELATED PRODUCTS*

FILLER PLATES

For extension of the stop to provide a proper mounting surface on the underside of the header. See figure 1B.

FP11V 1/8" x 1 1/4" x 11"

FP12V 1/4" x 1 1/4" x 11"

FP13V 3/8" x 1 1/4" x 11"

FP14V 1/2" x 1 1/4" x 11"

FP15V 5/8" x 1 1/4" x 11"

FP21V 1/8" x 1 1/4" x 22"

FP22V 1/4" x 1 1/4" x 22"

FP23V 3/8" x 1 1/4" x 22"

FP24V 1/2" x 1 1/4" x 22"

FP25V 5/8" x 1 1/4" x 22"

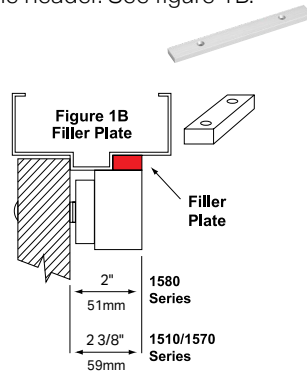

ANGLE BRACKETS

Used as extension on shallow door frames to provide adequate mounting surface. See figure 1C.

AB11V 1" x 1" x 11"

AB12V 1" x 1 1/2" x 11"

AB13V 1 1/2" x 1 1/2" x 11"

AB14V 2" x 1 1/2" x 11"

AB21V 1" x 1" x 22"

AB22V 1" x 1 1/2" x 22"

AB23V 1 1/2" x 1 1/2" x 22"

AB24V 2" x 1 1/2" x 22"

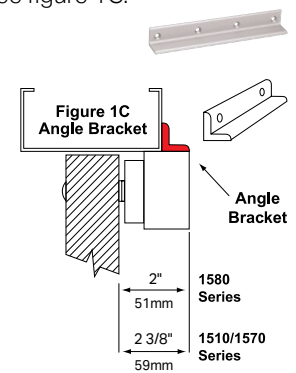

TOP JAMB MOUNTING KITS

Accommodate the installation of a standard magnetic lock to the pull-side of hollow metal door openings.

TJ1V Top Jamb Kit, Single

TJ2V Top Jamb Kit, Double



GLASS DOOR MOUNTING KITS

Accommodate the installation of the lock armature assemblies to glass doors without top rails. Field adjustable for 3/8", 1/2" and 5/8" glass herculite doors.

HDB1V 2 1/2" x 1 1/2" x 8 1/2"

HDB2V 2 1/2" x 1 1/2" x 8 1/2", Qty 2



SPACER BRACKETS

For aluminum frames with blade stop and concrete filled hollow metal frames. SDC's spacer bracket lowers the lock below blade stop to ensure proper function in aluminum frames and provides multiple points for concealed wire entry in concrete filled hollow door frames.

UF11V 1/2" x 1 1/2" x 11"

UF12V 1/2" x 1 1/2" x 22"



HEADER BRACKETS

Used in lieu of angle brackets, SDC's header brackets provide a faster mounting solution with a machined wire chase, pre-drilled and countersunk holes for frame mounting, and pre-drilled and tapped holes for lock mounting.

UB11V 1" x 1" x 11"

UB12V 1" x 1" x 22"



ARMATURE MOUNTING PLATES

Accommodate the installation of magnetic lock armature to the top rail of herculite, aluminum and glass, wood and hollow metal doors that do not permit the use of thru bolts.

AR11Y 5/8" x 3" x 8 1/2"

AR11YD 5/8" x 3" x 8 1/2", DPS



DOOR COORDINATOR BRACKETS

Designed for use on pairs of doors when one door needs to close before the other in proper order for latching to occur. SDC's door coordinator brackets prevent the inadvertent disabling of the coordinator.

DC-1 1 1/2" x 3" x 11"

DC-2 1 1/2" x 3" x 22"



REUSABLE DRILL FIXTURES

1511-DF Heavy Duty Drill Fixture for 1511, 1571 EMLock Installations



* Consult factory for special finishes.

COMPONENT CONSIDERATIONS

EMERGENCY DOOR RELEASES

[CLICK TO VIEW](#)



SDC's line of emergency door releases (EDR's) are designed to provide a physical method of unlocking an electronic lock in the event of an emergency and may influence the approval of an electric locking system. EDR's are usually fitted to emergency exit doorways in higher security areas. Our EDR's can initiate the release of an individual door or all doors on the same circuit and provide an auxiliary contact remote monitoring, CCTV activation or alarm activation.

KEY SWITCHES

[CLICK TO VIEW](#)



Early forms of access control began as manual key switches. Under SDC, key switches have evolved into an electrified access control method. SDC key switch assemblies provide an economical method of providing authorized control for a variety of applications and new or retrofit construction. Compatibility with a new or existing facility mechanical key system is maintained through the use of U.S. standard, 1" and 1 3/8" mortise key cylinders and interchangeable core cylinders (not included).

EXIT SWITCHES & SENSORS

[CLICK TO VIEW](#)



SDC offers a variety of exit button and push button styles and contact configurations to fit several request-to-exit application needs. Additionally, SDC's wave-to-open switches and motion sensors provide hands free compliance and convenience for touchless applications using proven infrared detection technology. A simple wave of the hand in front of our touchless switch models activates the switch to control electric locks/strikes, magnetic locks or automatic door operators for entry or egress.

EGRESS DEVICES

[CLICK TO VIEW](#)



SDC egress devices are designed for the release of magnetic locks and the activation of delayed egress locks installed on non-latching doors. Request-to-exit push bars provide uninhibited egress through access-controlled openings equipped with magnetic locks, while eliminating the need for prior knowledge of egress operation and enabling egress with a single natural motion. Request-to-exit push bars also eliminate the need for wall mounted exit switches requiring prior knowledge to unlock the door.

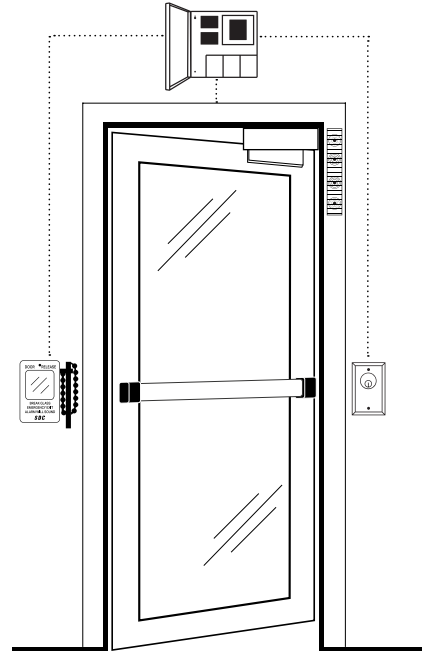

POWER CONTROLLERS

[CLICK TO VIEW](#)



SDC access control power supplies have been developed specifically to support access controls and electric locking hardware. They are UL listed and provide filtered and regulated linear DC power, with optional control logic, component interface, alarm interface and battery back-up to meet the requirements of single and multiple access-controlled openings. The circuitry design is ideal for the inductive loads generated by access control hardware for high performance and longevity.

DOOR PROP ALARMS & ANNUNCIATORS

[CLICK TO VIEW](#)



Multi-mode annunciators, like SDC's EA series door prop alarm, EA100 and 400 series LEDs, sirens, buzzers and speakers come in a variety of door, frame, wall, ceiling or single and double gang box configurations to provide the ultimate in door status indication, access control system compatibility and control. SDC door prop alarms are compatible with all access control systems but can also function as a standalone solution.