

CONDENSED CATALOG

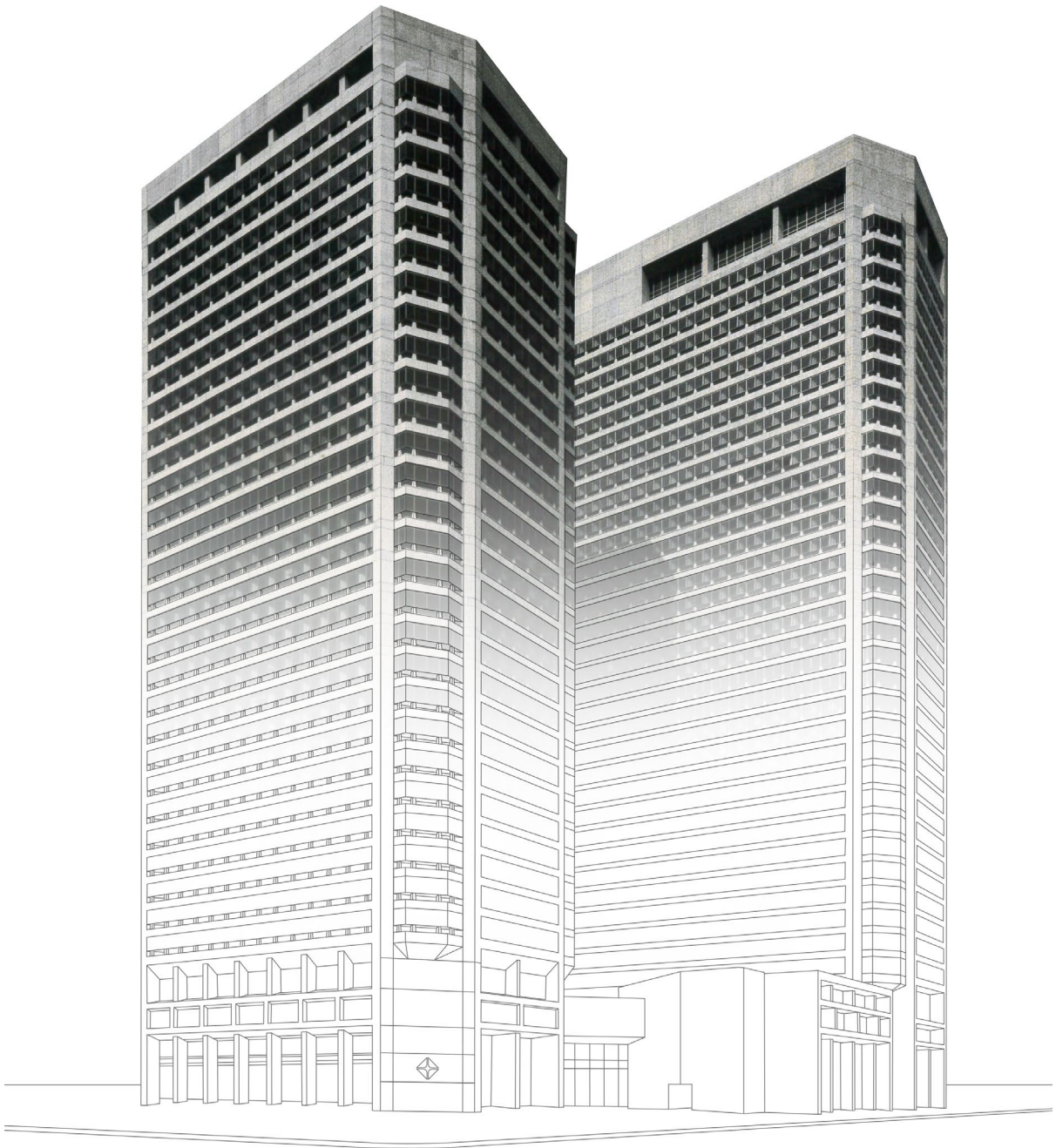

Electrified Access Control Hardware

the lock behind the system



DESIGNED, ENGINEERED AND BUILT IN AMERICA

SECURITY DOOR CONTROLS manufactures electrified access control hardware and controllers worldwide. Since 1972, SDC products have been designed, engineered and built in America while most of our larger competitors manufacture overseas.

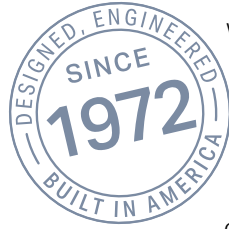

was removed. His first solution was rejected because it relied upon springs to unlock – deemed unacceptable by the fire marshal. Undaunted, Art remembered little magnetized toy dogs that would repel each other when one dog smelled the other dog’s tail and realized a

SDC is the bridge from mechanical access control to electrified security systems. SDC offers premium, code-compliant products to allow users a seamless transition into electronic access control. With a robust toolbox of over 35,000 access and egress control components, SDC products form turnkey solutions to address almost any door opening imagined.

solution was there. He invents the FS23 series electric bolt lock which utilizes two repelling magnets to repel the bolt from the strike even if the spring should fail. The fire marshal approved it on the spot.



HOW IT ALL BEGAN

Our founder, Arthur V. Geringer, was born in 1923 and grew up in his father’s architectural hardware business in Chicago. After serving in the US Army during World War II, he returned to civilian life in 1945. He settled in California and was employed at a major Los Angeles contract hardware firm before moving to an automatic door firm. While there



In 1972, Art patented the lock and approached his employer to manufacture it, who did not share Art’s intensity and enthusiasm for developing electric locking capabilities. The next day, Art resigned and with his wife, Mae, founded Security Door Controls in Tarzana, California – in the San Fernando Valley area of Los Angeles County.

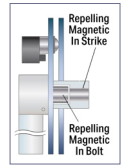

Art received his certification as an Architectural Hardware Consultant in 1952, allowing him to combine his industry experience with his energy and passion for innovation for the next 60 years.

The great migration to electric locking systems had begun.

In 1971, Art was asked by the California State Fire Marshal to create a failsafe bolt lock for perimeter doors that would unlock automatically when the power

As the inventor of numerous electronic lock designs our founder, Art Geringer, is credited with ushering in the modern era of access control hardware. His design for a lock that relied on magnets rather than mechanical springs, and his subsequent development of a 90° throw electric lock were foundational innovations that began the great migration to electric locking systems throughout the world. During the 1970’s, his was one of only two locks in the country approved for locking commercial stairwell and perimeter doors.

On the cover: ARCO Towers, Los Angeles, 1972. The ARCO Towers were the first of thousands of hi-rise buildings to incorporate SDC locks. Beginning in the 1970’s, SDC HiTower® locksets, FS23 series electric bolt locks, and Spacesaver® electric bolt locks became the basis for industry standard security and fire life safety specifications used in high rises and facilities throughout the world.

TODAY

SDC is credited with innovating a number of additional industry firsts including, but not limited to these selected highlights:

SDC Selectric® *SDC ExitAnnunciator®* *SDC EntryControl™*
SDC EMLock® *SDC IPPro®* *SDC UniFLEX™*
SDC Spectra™ *SDC SureExit®* *SDC Electra™* *SDC HiTower®*
SDC QuietDuo™ *SDC PanicLok™* *SDC ExitCheck®*
SDC Selectric® *SDC Spacesaver®* *SDC EntryCheck™*
SDC HiShear® *SDC GateLok™* *SDC Excel®*

- The one and only HiTower® locksets
- The first electric strikes with interchangeable faceplates and field reversibility for failsafe or failsecure operation - UniFLEX™
- The first electromagnetic locks with an interlocking quick mount assembly - EMLocks®
- The first floating armature for electromagnetic shear locks
- The first to design a delayed egress lock, followed by the first to include onboard electronics and visual and verbal countdown - ExitCheck®
- The first to design interlocks, mantraps, and shared bathroom controls with prommable logic boards
- The first pressure sense exit bar - SureExit® - to allow immediate release of electromagnetic locks and still the only tri-failsafe exit bar available today
- The first motorized electric latch retraction kits – QuietDuo™ LR100 series – enabling electrification of mechanical exit devices, leading the industry transition from solenoids to motors

WHO WE ARE

We're known as the Door Control Opening experts, with more than 40 patents, 20+ active trademark brands and decades of product design firsts. SDC's locking systems can be found in virtually any application where access control of a door is required. We're particularly adept at new or retrofit applications of 1 – 10 doors, where 80% of the security door and hardware market exists. We provide savings and profits to our partners through:

- Lower installation costs
- Fewer callbacks, increased longevity
- High-touch service from a family-run enterprise

To learn more about SDC's innovation and industry firsts, visit: sdsecurity.com/50-years and download the Getting to Know SDC brochure.

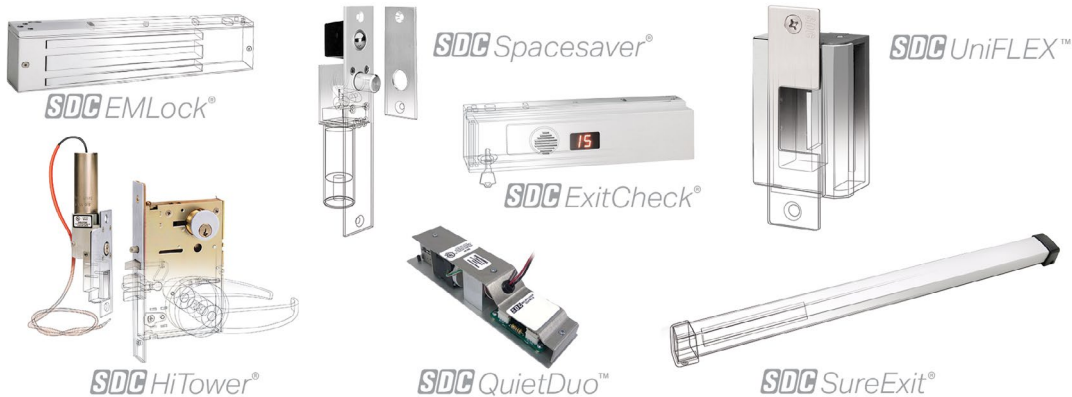

TABLE OF CONTENTS

LOCKING DEVICES

- Traditional Electromagnetic Locks 6
- Specialty Electromagnetic Locks 7
- Electromagnetic Shear Locks. 8
- Delayed Egress Locks. 9
- Electric Strikes 10
- Electrified Locksets 11
- Exit Devices & Retrofit ELR Kits 12
- Right Angle Electric Bolt Locks 13
- Conventional Direct Throw & Specialty Electric Bolt Locks 14

ACCESS CONTROLS

- IP-Based Controllers. 16
- Keypad & Readers 17
- Standalone Locksets 18
- Key Switches. 19

EGRESS CONTROLS

- Egress Devices 21
- Exit Switches. 22
- Exit Sensors 23
- Emergency Door Releases. 24

ADA CONTROLS

- Low Energy Operators. 26
- Push Plate & Panels 27
- Bollards 28

POWER TRANSFER DEVICES

- Power Transfer Devices. 30

POWER SUPPLY & DOOR CONTROLS

- Power Controllers 32
- Microprocessor-Based Door Controllers. 33
- Door Controllers 34

REMOTE CONTROLS & ANNUNCIATORS

- Remote Control Consoles 36
- Door Prop Alarms & Annunciators. 37

ACCESSORIES & MISC

- Electromagnetic Door Holders 39
- Door Position Status Monitoring 40
- Miscellaneous. 41

LOCKING DEVICES

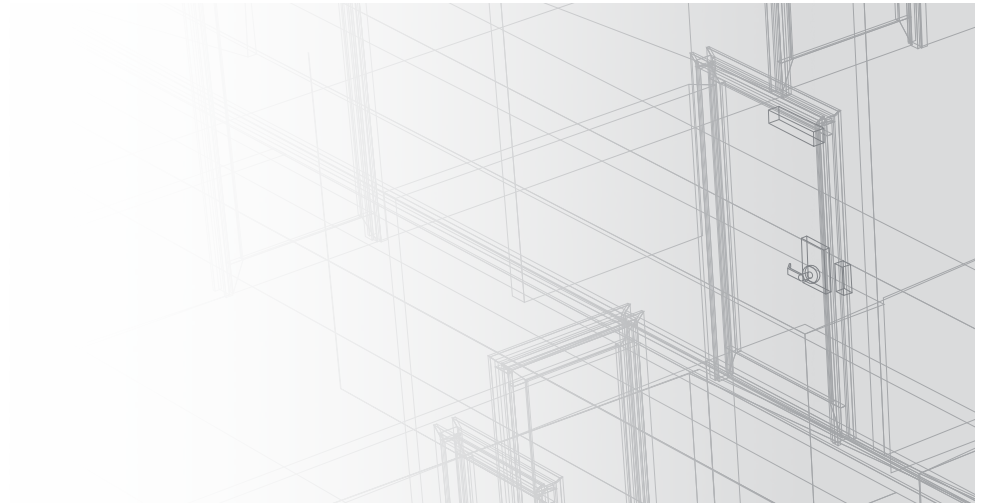

SDC's comprehensive electric locking device solutions can be found worldwide in virtually any application where access and egress control of a door is required. Our locking devices are designed, tested and proven to robustly perform in the most demanding situations and meet local, regional and national fire and life safety

code requirements with reliability and longevity. They are the seminal product innovations upon which we were founded and serve as the industry standard – the “bridge” – for converting from mechanical to electronic access control in new or retrofit door opening installations.

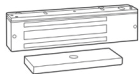

Electromagnetic Locks

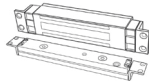

Electromagnetic Shear Locks

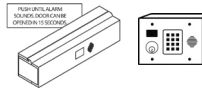

Delayed Egress Locks

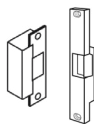

Electric Strikes



Electrified Locksets

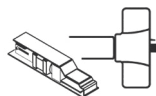

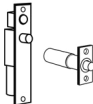

Exit Devices & Retrofit ELR Kits

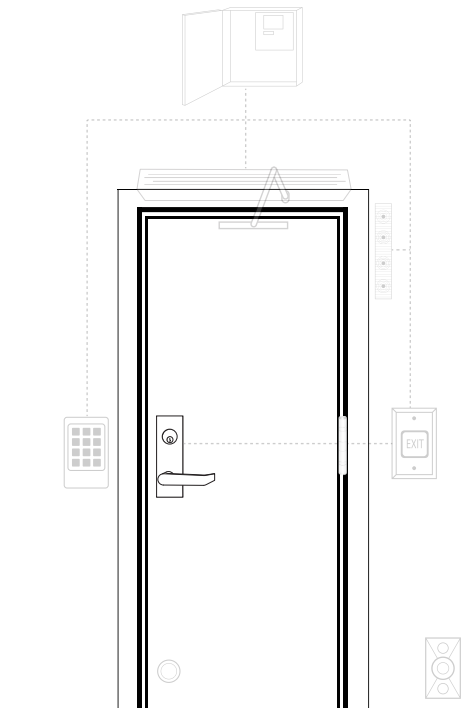

Electric Bolt Locks

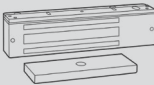
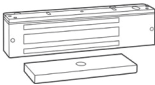
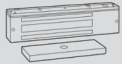
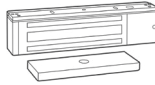
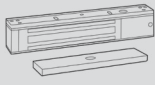

Traditional Electromagnetic Locks

Series	1510	1570	1580	E1200	E600	E6200
						
Trademark	EMLock®	EMLock®	EMLock®	Excel™	Excel™	-----
Type	Traditional	Traditional	Traditional	Traditional	Traditional	Traditional
Holding Force	1,650 lbs	1,200 lbs	650 lbs	1,200 lbs	600 lbs	1,200 lbs
Single	1511	1571	1581	E1200	E600	E6200
Double	1512	1572	1582	-----	-----	-----
Monitoring	Optional or Field Upgrade Kits	Optional or Field Upgrade Kits	Optional	Standard	Standard	Standard
Interlocking Mount	Yes	Yes	Yes	Yes	Yes	-----
Dual Voltage	Auto-Sensing	Auto-Sensing	Auto-Sensing	Field Selectable	Field Selectable	Field Selectable
Finishes	628, 335, 605, 710, 626, 625	628, 335, 605, 710, 626, 625	628, 335, 605, 710, 626, 625	628	628	630
UL	UL1034, UL10B, UL10C, ULC-S104, ULC-S533	UL1034, UL10B, UL10C, ULC-S104, ULC-S533	UL1034, UL10B, UL10C, ULC-S104, ULC-S533, UL294	UL864	UL864	UL864
Warranty	Lifetime	Lifetime	Lifetime	5 Year	5 Year	5 Year
Buy American	Yes	Yes	Yes	-----	-----	-----



1511V
1571V
1581V



1512V
1572V
1582V



E1200

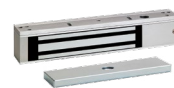

E600



E6200

Popular Configurations

- 1511V** Single EMLock, 1650lbs, 628
- 1571V** Single EMLock, 1200lbs, 628
- E1200** Value Single Magnetic Lock, 1200lbs, 628, DPS, BAS, LED
- 1581V** Single EMLock, 650lbs, 628
- 1581VD** Single EMLock, 650lbs, 628, DPS
- E600** Value Single Magnetic Lock, 600lbs, 628, DPS, BAS, LED
- 1571VD** Single EMLock, 1200lbs, 628, DPS
- 1512V** Double EMLock, 1650lbs, 628
- 1511VD** Single EMLock, 1650lbs, 628, DPS
- 1572V** Double EMLock, 1200lbs, 628
- 1511VBA** Single EMLock, 1650lbs, 628, BAS, ATS
- 1511VL** Single EMLock, 1650lbs, 628, LED

Mounting Kits & Hardware

- FP14V** 1511, 1571 Filler Plate, 1/2" x 1 1/4" x 11"
- AB13V** 1511, 1571 Angle Bracket, 1/2" x 1 1/2" x 11"
- TJ1V** 1511, 1571 Top Jamb Mounting Kit
- TJ81V** 1581 Top Jamb Mounting Kit
- HDB1V** 1511, 1571, 1581 Glass Door Mounting Kit
- UB11V** 1511, 1571 Header Bracket, 1" x 1" x 11"
- UF11V** 1511, 1571 Spacer Bracket, 1/2" x 1 1/2" x 11"
- E12Z** E1200 Top Jamb Mounting Kit
- E12U** E1200 Glass Door Mounting Kit

For a complete list of all available mounting kits and hardware, please refer to the product datasheets.

Specialty Electromagnetic Locks

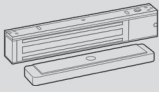
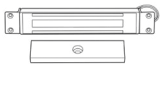
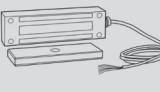
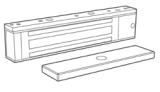
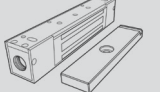
Series	350	1590	1575 / 1576	E300	EP17624
					
Type	Specialty	Specialty	Specialty	Specialty	Specialty
Application	Narrow	Sliding Doors	Outdoor Gates	Cabinets	Hazardous
Weatherized	-----	-----	Yes	-----	Explosion Proof
Holding Force	1,200 lbs	850 lbs	1,200 lbs	300 lbs	600 lbs
Single	350V	1591U	1575U, 1576U	E300	EP17624, EP17624TJ
Double	352V	-----	-----	-----	-----
Monitoring	Standard	Optional	Standard	Standard	Standard
Interlocking Mount	Yes	-----	-----	Yes	Yes
Dual Voltage	Field Selectable	Field Selectable	Field Selectable	Field Selectable	-----
Finishes	628	630	630	628	628
UL	UL864, ULC-S527	UL1034, UL10B, UL10C, ULC-S104, ULC-S533	UL1034, UL10B, UL10C, ULC-S104, ULC-S533	UL864	UL228, UL Classified
Warranty	5 Year	5 Year	1 Year	5 Year	5 Year
Buy American	-----	Yes	-----	Yes	-----



350V



352V



1591U



1575U



1576U



E300



EP17624

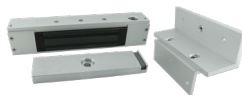

EP17624TJ



Popular Configurations

- 350V** Narrow Single Magnetic Lock, 1200lbs, 628, DPS, BAS, LED
- 352V** Narrow Double Magnetic Lock, 1200lbs, 628, DPS, BAS, LED
- 1591U** Sliding Door Single Magnetic Lock, 850lbs, 630
- 1591UDPS** Sliding Door Single Magnetic Lock, 850lbs, 630, DPS
- 1575U** Gate Single Magnetic Lock, 1200lbs, Weatherized, 630, DPS, BAS
- 1576U** Gate Single Magnetic Lock, Face-Drilled, 1200lbs, Weatherized, 630, DPS, BAS
- E300** Cabinet Single Magnetic Lock, 300lbs, 628, BAS
- EP17624** Explosion Proof Single Magnetic Lock, Side Conduit, 600lbs, 628, DPS
- EP17624TJ** Explosion Proof Single Magnetic Lock, Top Conduit, 600lbs, 628, DPS

Mounting Kits & Hardware

- TJ350** 350V Top Jamb Mounting Kit
- TJ352** 352V Top Jamb Mounting Kit
- HDB350V** 350V Glass Door Mounting Kit
- HDB352V** 352V Glass Door Mounting Kit
- LAB** 1591U Sliding Door Angle Bracket
- AMP** 1591U Sliding Door Armature Bracket
- 1575-BK** 1575 Angle Bracket
- 1576-AB** 1576 Armature Mounting Bracket
- 1576-BK** 1576 Angle Bracket
- 1576-MP** 1576 Lock Body Mounting Plate
- 1576-ZBV** 1576 Z Bracket

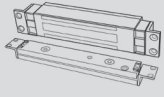
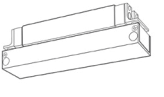
Electromagnetic Shear Locks

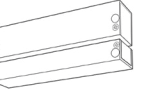
Series	1560	1562SC	1561S	1561TJ
				
Trademark	HiShear®	HiShear®	HiShear®	HiShear®
Type	Concealed	Semi-Concealed	Surface	Surface Top Jamb
Integrated Electronics	1561 1565	-----	1561S	1561TJ
External Electronics	1562 1566	1562SC 1562SCHDB 1562SCHDB3/4	-----	-----
Holding Force	2,000 - 2,700 lbs	2,000 lbs	Surface	Surface Top Jamb
Floating Armature	Yes	Yes	Yes	Yes
Relock Sensor	Yes	Yes	Yes	Yes
Adjustable Alignment	Lateral and Vertical	Lateral and Vertical	Lateral and Vertical	Lateral and Vertical
Monitoring	Optional	Optional	Optional	Optional
Dual Voltage	Auto-Sensing	Auto-Sensing	Auto-Sensing	Auto-Sensing
Finishes	628	628, 335, 605, 710, 626, 625	628, 335, 605, 710, 626, 625	628, 335, 605, 710, 626, 625
UL	UL10C, ULC-S104, ULC-S533	UL10C, ULC-S104, ULC-S533	UL10C, ULC-S104, ULC-S533	UL10C, ULC-S104, ULC-S533
Warranty	5 Year	5 Year	5 Year	5 Year
Buy American	Yes	Yes	Yes	Yes

Popular Configurations

1562ITC	Concealed, Integrated Electronics, 2000lbs, 7/8" to 1 1/8" Inverted Top Channel
1565ITC	Concealed, Integrated Electronics, 2700lbs, 7/8" to 1 1/8" Inverted Top Channel
1561ITC	Concealed, Integrated Electronics, 2000lbs, 7/8" to 1 1/8" Inverted Top Channel
1562ITCD	Concealed, Integrated Electronics, 2000lbs, 7/8" to 1 1/8" Inverted Top Channel, DPS
1561ITCD	Concealed, Integrated Electronics, 2000lbs, 7/8" to 1 1/8" Inverted Top Channel, DPS
1561ITCDB	Concealed, Integrated Electronics, 2000lbs, 7/8" to 1 1/8" Inverted Top Channel, DPS, BAS
1565ITCD	Concealed, Integrated Electronics, 2700lbs, 7/8" to 1 1/8" Inverted Top Channel, DPS
1561SV	Surface, Integrated Electronics, 2000lbs, 628
1561TJV	Surface Top Jamb, Integrated Electronics, 2000lbs, 628
1561TJVDB	Surface Top Jamb, Integrated Electronics, 2000lbs, 628, DPS, BAS
1566ITC	Concealed Shear, External Electronics, 2700lbs, 7/8" to 1 1/8" Inverted Top Channel
1561SVD	Surface, Integrated Electronics, 2000lbs, 628, DPS



1561ITC



1562ITC





1562SCV



1561SV

Delayed Egress Locks

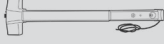
Series	1511S	1511T	1581S	101-DE	S6000-101
					
Trademark	ExitCheck®	ExitCheck®	-----	ExitCheck®	-----
Type	EMLock	EMLock	EMLock	Controller	Exit Device
DE System	Integrated	Integrated	Integrated	Two-Piece	Integrated
DE Activation	Built-In	Built-In	Built-In	Slave Unit	Built-In
Holding Force	1,650lbs	1,650lbs	650lbs	-----	-----
Monitoring	Optional	Optional	Optional	-----	Standard
Interlocking Mount	Yes	Yes	Yes	-----	-----
Dual Voltage	Auto-Sensing	Auto-Sensing	Auto-Sensing	Auto-Sensing	-----
Finishes	628, 335, 605, 710, 626, 625	628, 335, 605, 710, 626, 625	628, 335, 605, 710, 626, 625	628	630
UL	UL294, UL10B, UL10C, ULC-S104, ULC-S533	UL294, UL10B, UL10C, ULC-S104, ULC-S533	UL294, UL10B, UL10C, ULC-S104, ULC-S533	UL294, UL10B, UL10C, ULC-S104, ULC-S533	UL305, UL10C
Warranty	5 Year	5 Year	5 Year	5 Year	5 Year
Buy American	Yes	Yes	Yes	Yes	Yes

Popular Configurations

- 1511SNAKV** Single, NFPA 101, Selectable Egress Delay, Keyswitch Reset, 628
- 1581SNDV** Mini, NFPA 101, Fixed 15 Sec Egress Delay, 628
- 1511SNAKVD** Single, NFPA 101, Selectable Egress Delay, Keyswitch Reset, 628, DPS
- 1511TNAKV** Tandem, NFPA 101, Selectable Egress Delay, Keyswitch Reset, 628
- 101-KDENA** Controller, Keyswitch Reset, NFPA 101, Selectable Egress Delay
- 1511SNDKV** Single, NFPA 101, Fixed 15 Sec Egress Delay, Keyswitch Reset, 628
- 1581SNDVD** Mini, NFPA 101, Fixed 15 Sec Egress Delay, 628, DPS
- 101-DENA** Controller, NFPA 101, Selectable Egress Delay
- 1511SNAKVDB** Single, NFPA 101, Selectable Egress Delay, Keyswitch Reset, 628, DPS, BAS
- 1511SBCKV** Single, Chicago Compliant, Keyswitch Reset, 628
- 1511TNAKVD** Tandem, NFPA 101, Selectable Egress Delay, Keyswitch Reset, 628, DPS
- S6101FU36101ND** Rim, Exit Only, Fire, 630, 36", All-In-One, NFPA 101, Fixed 15 Sec Egress Delay

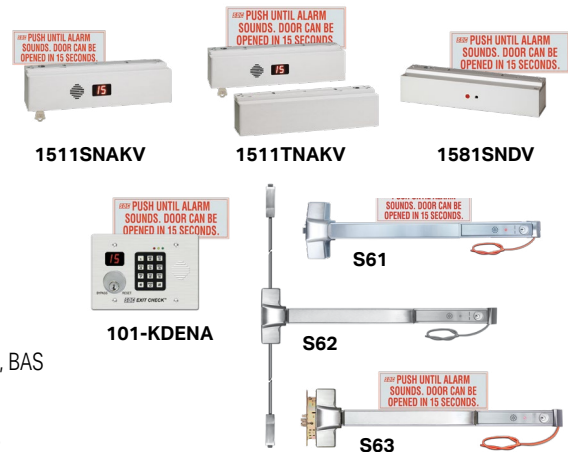



Delayed Egress Key Switches, Speakers & Annunciators

- 702RU** Key Switch, Reset, MO
- 707RU** Key Switch, Reset & Bypass, MO
- 708RU** Key Switch, Reset & Bypass, AA
- 728RU** Keylock Switch, Reset & Bypass, AA
- 728RUL3** Keylock Switch, Reset & Bypass, AA, LED
- 101-SP** External 15 Watt Speaker
- 101-SPSN** Remote 80db Siren & Speaker
- 101-1A** Single Door Indicator
- 101-4AM** Four Door Indicator, Alarm Shunt
- 101-1AK** Single Door Indicator, Key Reset & Bypass
- 101-PAM** Single Door Indicator, Alarm Shunt, Push Reset & Bypass

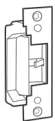

Electric Strikes

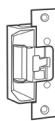
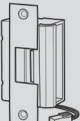
Series	15	25	30	45	55
					
Trademark	-----	-----	-----	UniFLEX™	UniFLEX™
Type	Value Cylindrical, 5/8" Latchbolt	Value Cylindrical, 1/2" Latchbolt	Rim, 3/4" Latchbolt	Cylindrical, 5/8" Latchbolt	Mortise, 3/4" Latchbolt
Adjustable Alignment	-----	-----	Yes	Yes	Yes
Interchangeable Faceplates	-----	-----	-----	Yes	Yes
Multi-Application Kits	-----	-----	-----	Yes	Yes
Latch Status (LS)	-----	Standard	Optional	Standard	Optional
Keeper Deadlocked Status	-----	-----	Optional	Standard	Optional
Keeper Open Status	-----	-----	-----	Optional	-----
Deadbolt Status	-----	-----	-----	-----	Optional
Dual Voltage	-----	Field Selectable	-----	Field Selectable	Field Selectable
Finishes	630	630	630	630, 606, 613, 628, 335	630, 629, 606, 605, 612, 611, 613, 626, 625
UL	-----	UL1034	UL294, UL1034, UL10B, UL10C	UL1034, UL10C	UL1034, UL10C
Warranty	5 Year	5 Year	5 Year	5 Year	5 Year
Buy American	-----	-----	-----	Yes	Yes



55-AU



55-BU



55-DU



55-FU



45-4SU



45F-4SU



30-4-24U



25-4U



15-4F24U

Popular Configurations

- 45-4SU** 5/8" Latchbolt Strike, 4 7/8" Square Corner Faceplate, 630
- 25-4U** Value 1/2" Latchbolt Strike, 630, LS
- 55-AU** 3/4" Latchbolt Strike, Cylindrical Faceplate, 630
- 55-BU** 3/4" Latchbolt Strike, Mortise - Deadlatch Below Faceplate, 630
- 45F-4SU** 9/16" Latchbolt Strike, Fire-Rated, 4 7/8" Square Corner Faceplate, 630
- 55-DUDBM-L** 3/4" Latchbolt Strike, Mortise - Deadlatch Below - Deadbolt Faceplate, 630, DS-LH
- 55-DUDBM-R** 3/4" Latchbolt Strike, Mortise - Deadlatch Below - Deadbolt Faceplate, 630, DS-RH
- 55-CU** 3/4" Latchbolt Strike, Mortise - Deadlatch Above Faceplate, 630
- 55-DU** 3/4" Latchbolt Strike, Mortise - Deadlatch Below - Deadbolt Faceplate, 630
- 55-FUDBM-L** 3/4" Latchbolt Strike, Mortise - Deadlatch Above - Deadbolt Faceplate, 630, DS-LH
- 45-4RV** 5/8" Latchbolt Strike, 4 7/8" Radius Corner Aluminum Faceplate, 628
- 15-4S24U** Value 5/8" Latchbolt Strike, Failsecure, 24VDC, 630

Multi-Application Kits

- 45-A** 45 Series Multi-Application Kit
- 55-ABCU** 55 Series Multi-Application Kit





45-A

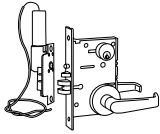
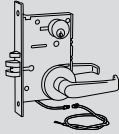
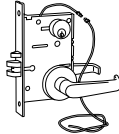
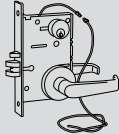

55-ABCU

Electrified Locksets

Series	7200	7500	7600	7700	7800	SK
						
Trademark	Electra™	HiTower®	----	----	Selectric®	----
Type	Cylindrical	Mortise	Mortise	Mortise	Mortise	Retrofit Mortise Kits
Electrification	Solenoid Control	Frame Actuator Control	MLR Control	MLR & Solenoid Control	Solenoid Control	Solenoid Control
Vandal Clutch	Yes	Yes	Yes	Yes	Yes	----
Selectable Operation	----	----	----	----	Yes	Yes
Selectable Function	----	----	Yes	----	Yes	----
Reversible Handing	----	----	Yes	----	Yes	----
Monitoring	Standard	Optional	Optional	Optional	Optional	S7800-REX
Dual Voltage	Field Selectable	----	----	----	Field Selectable	Field Selectable
Finishes	626, 625, 605, 606, 613	626, 625, 605, 606, 611, 612, 613, 630, 629	626, 625, 605, 606, 611, 612, 613, 630, 629	626, 625, 605, 606, 611, 612, 613, 630, 629	626, 625, 605, 606, 611, 612, 613, 630, 629	----
UL	UL10C, ULC-S104	UL10C, ULC-S104	UL10C, ULC-S104	UL10C, ULC-S104	UL10C, ULC-S104	UL10C, ULC-S104, UL Classified
Warranty	5 Year	5 Year	5 Year	5 Year	5 Year	3 Year
Buy American	Yes	Yes	Yes	Yes	Yes	Yes



Z7252EQ

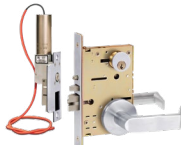

Z7550LCQE



Z7652LQE



Z7752LQE

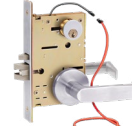

Z7852LQE



SK-L90

Popular Configurations

- Z7252EQ** Solenoid Cylindrical, Outside Only, Failsecure, Eclipse Rose, 626
- Z7250EQ** Solenoid Cylindrical, Outside Only, Failsafe, Eclipse Rose, 626
- Z7252EQ6PKA** Solenoid Cylindrical, Outside Only, Failsecure, Eclipse Rose, 626, 6-Pin Keyed Alike
- Z7252E5QR** Solenoid Cylindrical, Outside Only, Failsecure, Eclipse Rose, I-Core Prep, 626, REX
- Z7252GQ** Solenoid Cylindrical, Outside Only, Failsecure, Galaxy Rose, 626
- Z7252G5QRIC7PKA** Solenoid Cylindrical, Outside Only, Failsecure, Galaxy Rose, I-Core Prep, 626, 7-Pin IC, Small Format, Keyed Alike
- SK-L90** Schlage L9070 Field Electrification Kit
- Z7852LQ** Solenoid Mortise, Outside Only, Failsecure, LH, 626
- Z7835RCQ** Solenoid Mortise, Outside and/or Inside, Failsecure Outside and Failsafe Inside, RH, 24VDC, 626
- Z7652RQ** MLR Mortise, Outside Only, Failsecure, RH, 626
- ZY7550LREQ07** HiTower Retrofit, Outside Only, Failsafe, LHR, Narrow Actuator, 626, Schlage 07 Rose
- Z7750RQL07** MLR & Solenoid Mortise, Outside Only, Failsafe, RH, 626, REX, LS, Eclipse Rose

Trim Styles



Eclipse Rose



Galaxy Rose



Nova Rose



Schlage 07 Rose



Eclipse Escutcheon



Galaxy Escutcheon



Nova Escutcheon



Schlage 07 Escutcheon

Exit Devices & Retrofit ELR Kits

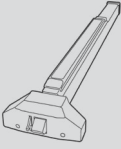
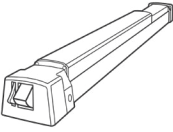
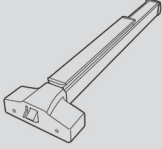
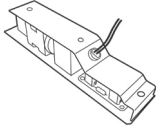
Series	S4000	S5000	S6000	LR100
				
Trademark	-----	-----	Spectra™	QuietDuo™
Type	Rim, SVR	Rim, CVR	Rim, SVR, Mortise	Retrofit ELR Kits
Application	Industrial	Storefront	Architectural	Retrofit
Door Width	36"	36", 42"	36", 42", 48"	-----
Door Stile	Wide (4" minimum)	Narrow (2 1/8" minimum)	Wide (4" minimum)	-----
Electrification	Motorized ELR	Motorized ELR	Motorized ELR, Electric Dogging, Alarmed Exit	Motorized ELR
Operator Compatible	Yes	Yes	Yes	Yes
Fire-Rated Devices	Yes	-----	Yes	Yes
Monitoring	Standard	Optional	Optional	Optional
Dual Voltage	-----	-----	-----	-----
Finishes	630	628, 335	630	-----
UL	UL305, UL10C	UL305	UL305, UL10C	UL305, UL10C, ULC-S104, UL Classified
Warranty	5 Year	5 Year	5 Year	5 Year
Buy American	Yes	Yes	Yes	Yes



Popular Configurations

- LR100VDK** Von Duprin Field Install ELR Kit, 98/99, 36" - 48" Opening
- LR100FAK** Dor-O-Matic Field Install ELR Kit, 1790/1690, 36" Opening
- LR100FCK** First Choice Field Install ELR Kit, 3790/3690, 36" Opening
- LR100SGK** Sargent Field Install ELR Kit, 8000, 36" - 48" Opening
- LR100ARK** Adams Rite Field Install ELR Kit, 8000/3000, 36" - 48" Opening
- LR100DMK** Dor-O-Matic Field Install ELR Kit, 1590/1490, 36" Opening
- LR100CRK** Corbin Russwin Field Install ELR Kit, 5000/4000, 36" - 48" Opening
- S6101PU36E** Rim, Exit Only, Panic, 630, 36", Motorized ELR & Dogging
- S6201PU36E** SVR, Exit Only, Panic, 630, 36", Motorized ELR & Dogging
- S4101PU36RE** Rim, Exit Only, Panic, 630, 36", REX, Motorized ELR & Dogging
- S5101PV36E** Rim, Exit Only, Panic, 628, 36", Motorized ELR & Dogging
- S4201FU36RE** SVR, Exit Only, Fire-Rated, 630, 36", REX, Motorized ELR & Dogging

Trim Styles

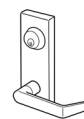

Eclipse Escutcheon

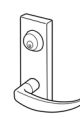

Galaxy Escutcheon



Saturn Escutcheon

Right Angle Electric Bolt Locks

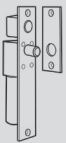
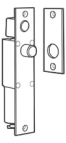
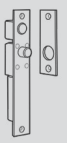
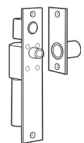
Series	1091 / 1291	1190 / 2090	1490 / 2490	FS23M
				
Trademark	Spacesaver®	Spacesaver®	Spacesaver®	Spacesaver®
Type	Right Angle	Right Angle	Right Angle	Right Angle
Application	Standard 1¾"	Heavy Duty	Narrow 1½"	Dual Failsafe
Failsafe	1091A	1190A	1490A	FS23M
Failsecure	1291A	2090A	2490A	-----
Bolt	Stainless Steel	Stainless Steel	Stainless Steel	Nylon, Magnet Core
Automatic Relock	Yes	Yes	Yes	Yes
Adjustable Relock	Yes	Yes	Yes	Yes
Monitoring	Optional	Optional	Optional	Optional
Dual Voltage	Field Selectable	Field Selectable	Field Selectable	Field Selectable
Finishes	628, 335, 605, 606, 611, 612, 613, 626, 625, 630, 629	630	628, 335, 605, 606, 611, 612, 613, 626, 625, 630, 629	628, 335, 605, 606, 611, 612, 613, 626, 625, 630, 629
UL	UL10C, ULC-S104, ULC-S533	UL10C, ULC-S104, ULC-S533	-----	UL10C, ULC-S104, ULC-S533
Warranty	5 Year	5 Year	5 Year	5 Year
Buy American	Yes	Yes	Yes	Yes



1091AIV



1091AIDMRV



1091AIDDMR1V



1190AIU



2090AHU



1490AIV



FS23MIV

Popular Configurations

1091AIV Right Angle Bolt Lock, Failsafe, 628

FS23MIV Right Angle Bolt Lock, Dual Failsafe, 628

1190AIU Heavy Duty Right Angle Bolt Lock, Failsafe, 630

1490AIV Narrow Right Angle Bolt Lock, Failsafe, 628

1291AHV Right Angle Bolt Lock, Failsecure, 628

2090AHU Heavy Duty Right Angle Bolt Lock, Failsecure, 630

1091AIVD Right Angle Bolt Lock, Failsafe, 628, DPS

1091AIVB Right Angle Bolt Lock, Failsafe, 628, BP



1091AIWDV Right Angle Bolt Lock, Wood Applications, Failsafe, 628

1291AHU Right Angle Bolt Lock, Failsecure, 630

1091AIDL Right Angle Bolt Lock, Deadlocking, Failsafe, 628

2490AHV Narrow Right Angle Bolt Lock, Failsecure, 628

Conventional Direct Throw & Specialty Electric Bolt Locks

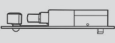
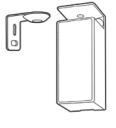
Series	100 / 200	GL	PD2090	290
				
Trademark	-----	GateLok™	PanicLok™	-----
Type	Conventional	Specialty	Specialty	Specialty
Application	Mortise or Surface Mount	Gate Lock	Panic Device Top Latch Release	Micro Cabinet
Weatherized	-----	Yes	-----	-----
Failsafe	110I, 160I, 180AI	GL160AI, GL163AI	-----	290
Failsecure	210H, 260H, 280AH	GL260AH, GL263AH, GL260MRAH	PD2090A	290
Bolt	Stainless Steel	Stainless Steel	Beveled Stainless Steel	Steel
Automatic Relock	160I, 180AI, 260H, 280AH	Yes	Yes	Yes
Adjustable Relock	110I, 160AI, 210H, 260AH	-----	Yes	-----
Monitoring	-----	Optional	Optional	Optional
Dual Voltage	Field Selectable	Field Selectable	-----	Field Selectable
Finishes	628	Black	630	Black
UL	-----	-----	UL10C, ULC-S104, ULC-S533	-----
Warranty	5 Year	5 Year	5 Year	5 Year
Buy American	Yes	Yes	Yes	-----



110IV



160IV



180IV



GL160AI



GL163AI



PD2090ALCU



290

Popular Configurations

- 110IV** Direct Throw Mortise Bolt Lock, Failsafe, 628
- 210HV** Direct Throw Mortise Bolt Lock, Failsecure, 628
- 290** Micro Cabinet Bolt Lock
- 280AHV** Direct Throw Surface Mount Bolt Lock, Failsecure, 628
- 290LS** Micro Cabinet Bolt Lock, BPS
- 180AIV** Direct Throw Surface Mount Bolt Lock, Failsafe, 628
- 160IV** Direct Throw Mortise Bolt Lock, Auto-Relock, Failsafe, 628
- PD2090ALCU** Panic Device Bolt Lock, Failsecure, LH/RHR, 630
- PD2090ARCU** Panic Device Bolt Lock, Failsecure, RH/LHR, 630
- 260HV** Direct Throw Mortise Bolt Lock, Auto-Relock, Failsecure, 628
- GL260MRAH** Gate Lock, Mechanical Release, Failsecure
- GL260MRAHDB** Gate Lock, Mechanical Release, Failsecure, DPS, BPS

ACCESS CONTROLS

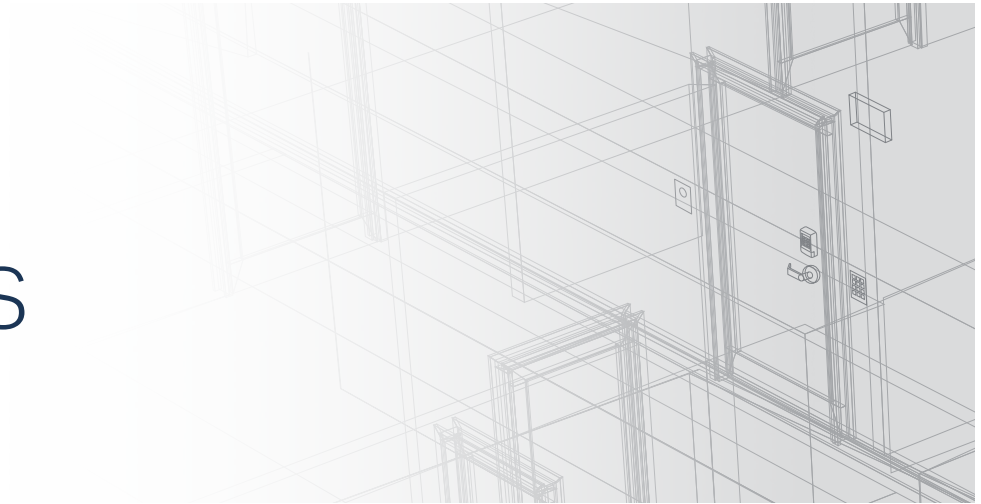

It's one thing to design and manufacture locking devices for door access and egress control, it's another thing to tie them all together with physical access control components and systems to both protect people and assets while ensuring code compliance. SDC's digital and card access control systems are engineered to provide real-world door control of 1 to 100 doors, from

indoor and stand-alone applications, to outdoor and PC-based systems. All while ensuring fire and life safety code compliance along with superior expandability and flexibility in authorization identification, authentication, access approval, and accountability of entities through login credentials - including passwords and personal identification numbers (PINs).



IP-Based Controllers

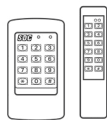

Keypads & Readers

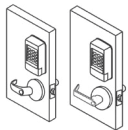

Standalone Locksets

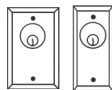

Key Switches

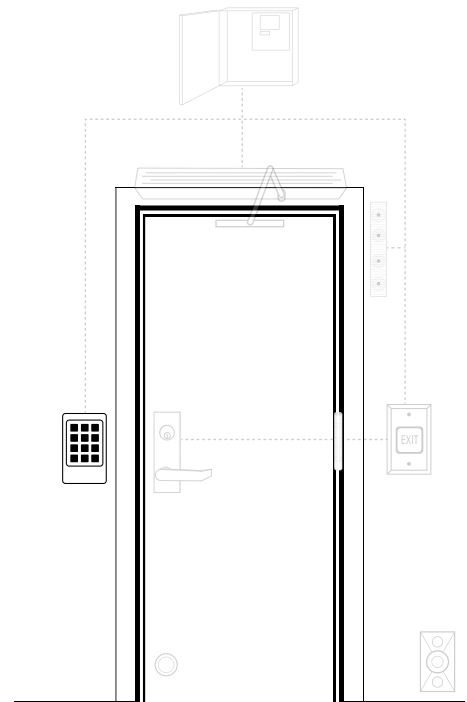

IP-Based Controllers

IPD Series

SAFE, SECURE & EASY TO IMPLEMENT NETWORK CONTROL

IPDCE IPPro Controller Board

IPDSE IPPro Door Station Expansion Board

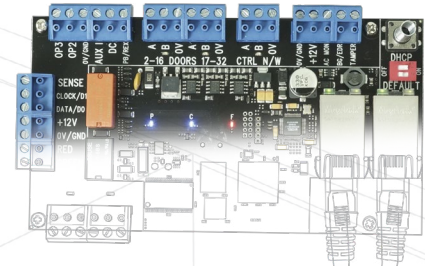

SDC IPPro®

UL 294

5 Year Warranty

1 - 32 Doors

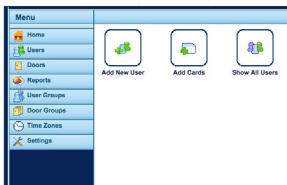

Browser-Based
No Software Required
Simple Installation and Setup

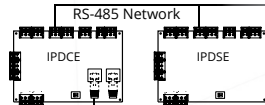

1 - 100 Doors



Free Role-Based Software
Different Interfaces By User Type
Two Ports Eliminate Long Cable Runs to Connect Additional IP Devices

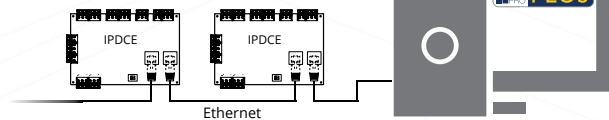

IPPro Kits

IPPRO-SKE IPPro Starter Kit
(IPDCE, IPI-30 and IPS-12 included)

602RFX12VRxIPDC IPPro Power Kit
(1 Amp Power Supply with Cabinet, Voltage Power Convertor and IPDC included)

602RFX12VRxIPDS IPPro Expansion Power Kit
(1 Amp Power Supply with Cabinet, Voltage Power Convertor and IPDS included)

Power Injectors & Splitters

IPI-30 IPPro Injector, 30W PoE+

IPS-12 IPPro Splitter, 12VDC PoE+



Wiegand Readers & Digital Keypads

IPRW300 Wiegand Reader, Mullion Mount

IPRW500 Wiegand Reader, Single Gang Mount

918WU Indoor Keypad, Wiegand Output

920PW Keypad with Integrated Proximity Reader, Wiegand Output

923PW Narrow Keypad with Integrated Proximity Reader, Wiegand Output



PLUS Hardware is used by the installer to set up controllers, doors and user profiles.

- Enable & edit IPPro controllers
- Enable & edit door settings
- Create event filters
- Enable e-mail notifications

PLUS Manage is used by system administrators to facilitate database changes required on a day-to-day basis, and offers various reporting tools.





- Create, view, & edit users
- Add access & holiday schedules
- Generate user & event reports

PLUS Server is used by system administrators to perform specialized tasks, such as database backups, firmware updates, importing/exporting users.

- Perform manual or schedule automatic backups
- Import/export users
- Perform IPPro firmware updates

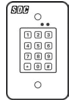
Live system events can be monitored from either module!

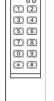
Keypad & Readers

Series	IPRW	918	920	923	926
					
Trademark	-----	EntryCheck™	EntryCheck™	EntryCheck™	-----
Type	Reader	Keypad & Reader	Keypad & Reader	Keypad & Reader	Keypad
Application	Inddor	Indoor	Indoor/Outdoor	Indoor/Outdoor	Outdoor
Mount	Mullion, Frame or Single Gang Wall	Single Gang Wall	Single Gang Wall or Surface	Mullion, Frame or Narrow Surface	Surface or Pedastal Post
Keypad Programmable	-----	Yes	Yes	Yes	Yes
Self Contained	-----	918	920, 920P	923, 923P	926
Integrated Prox	-----	-----	920P, 920PW	923, 923PW	-----
Weigand Output	IPRW300, IPRW500	918W	920PW	923PW	-----
Finishes	Black, White	630, 605, 606, 613, 625	Aluminum	Black	Aluminum
UL	-----	-----	-----	-----	-----
Warranty	5 Year	5 Year	5 Year	5 Year	5 Year
Buy American	-----	Yes	Yes	Yes	Yes



918U



920



920P



921P



923



923P



926

Popular Configurations





- 918U** Indoor Self-Contained Keypad, 630
- 920** Indoor/Outdoor Self-Contained Keypad
- 923** Indoor/Outdoor Narrow Self-Contained Keypad
- 920P** Indoor/Outdoor Self-Contained Keypad with Integrated Prox
- 923P** Indoor/Outdoor Narrow Self-Contained Keypad with Integrated Prox
- 920PW** Indoor/Outdoor Weigand Output Keypad with Integrated Prox
- 923PW** Indoor/Outdoor Narrow Weigand Output Keypad with Integrated Prox
- IPRW300** Weigand Reader, Mullion Mount
- IPRW500** Weigand Reader, Single Gang Mount
- 926** Outdoor Self-Contained Keypad
- 918WU** Indoor Weigand Output Keypad, 630
- 918H** Indoor Self-Contained Keypad, 613

Prox Cards, Fobs & Tags

- HID1326-10** Card Pack, Quantity 10
- HID1326-25** Card Pack, Quantity 25
- HID1326-100** Card Pack, Quantity 100
- HID1346-10** Key Fob Pack, Quantity 10
- HID1346-100** Key Fob Pack, Quantity 100
- PTAG-10** Disc Tag Pack, Quantity 10
- PTAG-25** Disc Tag Pack, Quantity 25

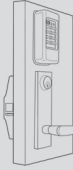

Standalone Locksets

Series	E75	E76	E77	295
				
Trademark	EntryCheck™	EntryCheck™	EntryCheck™	-----
Type	Cylindrical	Mortise	Exit Device	Cabinet
Battery Powered	4 AA	4 AA	4 AA	2 AAA
Keypad Only	E75K	E76K, E76+K	E77K	
Integrated Prox	E75P	E76P, E76+P	E77P	
Integrated Prox & Software	E75PS	E76PS, E76+PS	E77PS	
Privacy Feature	E75KL, E75PL	-----	-----	-----
Key Override	Yes	Yes	Yes	Yes
Monitoring	Standard	Standard	Standard	-----
Finishes	626, Black	626, Black	626, Black	Black
UL	UL10C, ULC-S104	UL10C, ULC-S104	UL10C, ULC-S104	-----
Warranty	5 Year	5 Year	5 Year	5 Year
Buy American	Yes	Yes	Yes	-----



E75KQE1Q



E76PQLEEQ



E77KQEKM61PU36



295



Keypad Only



Keypad Prox



Prox Software

Popular Configurations

- 295** Standalone Programmable Cabinet Lock
- E75KQE1Q** Standalone Cylindrical Lockset, Keypad Only, 626, Eclipse Rose, 626
- E75KQG1Q** Standalone Cylindrical Lockset, Keypad Only, 626, Galaxy Rose, 626
- E75PSQE1Q** Standalone Cylindrical Lockset, Keypad w/ Prox & Software, 626, Eclipse Rose, 626
- E75PQE1Q** Standalone Cylindrical Lockset, Keypad w/ Prox, 626, Eclipse Rose, 626
- E77KQEKM61PU36** Standalone Rim Device Lockset, Keypad Only, 626, Eclipse Escutcheon, Panic, 630, 36"
- E77PSQEKM61PU36** Standalone Rim Device Lockset, Keypad w/ Prox & Software, 626, Eclipse Escutcheon, Panic, 630, 36"
- E75PQG1Q** Standalone Cylindrical Lockset, Keypad w/ Prox, 626, Galaxy Rose, 626
- E77PSQGKM61PU36** Standalone Rim Device Lockset, Keypad w/ Prox & Software, 626, Galaxy Escutcheon, Panic, 630, 36"
- E75PSQG1Q** Standalone Cylindrical Lockset, Keypad w/ Prox & Software, 626, Galaxy Rose, 626
- E75KLQE1Q** Standalone Cylindrical Lockset, Keypad w/ Privacy, 626, Eclipse Rose, 626
- E75KLBG5C** Standalone Cylindrical Lockset, Keypad w/ Privacy, Matte Black, Galaxy Rose, I-Core Prep, 605

Key Switches

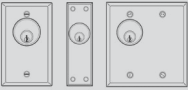
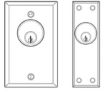
Series	700	800AL
		
Type	Mortise Cylinder	Mortise Cylinder
Faceplate	Stainless Steel	¼" Aluminum
Models	Alternate Action (AA), Momentary (MO)	Alternate Action (AA), Momentary (MO)
Size	Narrow, Single Gang, Double Gang	Narrow, Single Gang
Contact	SPDT or DPDT	SPDT or DPDT
Recessed Cylinder Prep	Single Gang, Double Gang	Narrow,, Single Gang
Spanner Screws	Yes	Yes
Compatible Key Cylinder	1" - 1⅜" Mortise	1" - 1⅜" Mortise
Monitoring	Optional	Optional
Finishes	630, 629, 606, 605, 613, 626, 625	Aluminum
UL	UL294	-----
Warranty	5 Year	5 Year
Buy American	Yes	Yes



701U



701NU



701TUL2SN



801ALN



801AL

Popular Configurations

- 701U** Single Gang, Alternate Action (AA) On/Off, SPDT, 630
- 702U** Single Gang, Momentary (MO), SPDT, 630
- 701UL2** Single Gang, Alternate Action (AA) On/Off, SPDT, 630, One Green & One Red LED
- 701NU** Narrow, Alternate Action (AA) On/Off, SPDT, 630
- 706U** Single Gang, Momentary (MO), DPDT, 630
- 702NU** Narrow, Momentary (MO), SPDT, 630
- 705U** Single Gang, Alternate Action (AA) On/Off, DPDT, 630
- 705UL2** Single Gang, Alternate Action (AA) On/Off, DPDT, 630, One Green & One Red LED
- 801AL** Single Gang, Alternate Action (AA) On/Off, SPDT
- 805AL** Single Gang, Alternate Action (AA) On/Off, DPDT
- 806AL** Single Gang, Momentary (MO), DPDT
- 802AL** Single Gang, Momentary (MO), SPDT

EGRESS CONTROLS



SDC's innovative exit bars, devices, switches and emergency door releases all comply with building safety codes by allowing exit through an access controlled opening. From glass doors to gates, interior to exterior,

wireless or hardwired, and ADA or emergency, there's an SDC Egress solution that provides safe and reliable security for any environment.

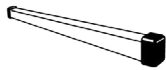

Egress Devices

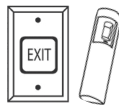



Exit Switches & Sensors

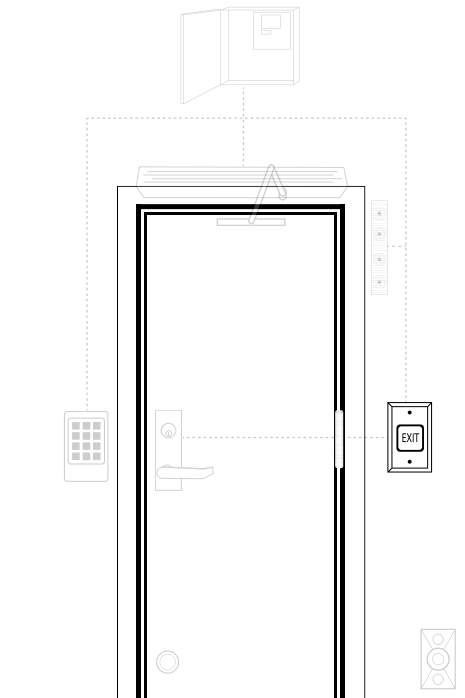

Emergency Door Releases

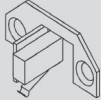

Egress Devices

Series	PSB560	MSB550	00500
			
Trademark	SureExit®	-----	-----
Type	Pressure Sense Bar	Mechanical Switch Bars	Retrofit Switch Kits
Key Feature	Tri-Failsafe	1/8" Total Bar Movement	-----
End Caps	Metal	Metal	-----
Weatherized	-----	MSB550-2W	-----
Door Width	36", 42", 48"	36", 42", 48"	-----
Door Stile	Narrow or Wide	Narrow or Wide	-----
Finishes	628, 335, 630, 629	628, 335, 630, 629	-----
UL	UL294, UL1034, CSFM	UL294, UL1034	-----
Warranty	5 Year	5 Year	5 Year
Buy American	Yes	Yes	Yes



PSB560V36



MSB550V36

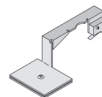

00510



00511



00512



00514

Popular Configurations

- MSB550-2V36** Dual Mechanical Switch Bar, 628, 36"
- PSB560V36** Pressure Sense Bar, 628, 36"
- MSB550V36** Mechanical Switch Bar, 628, 36"
- MSB550-2Y36** Dual Mechanical Switch Bar, 335, 36"
- MSB550Y36** Mechanical Switch Bar, 335, 36"
- PSB560Y36** Pressure Sense Bar, 335, 36"
- MSB550-2WV36** Dual Mechanical Switch Bar, Weatherized, 628, 36"
- 00510** Retrofit Switch Kit, Von Duprin 33, 35, 98, 99
- 00527** Retrofit Switch Kit, Sargent 80 & Arrow S3800, S120
- MSB550V48** Mechanical Switch Bar, 628, 48"
- MSB550-2V48** Dual Mechanical Switch Bar, 628, 48"
- MSB550U36** Mechanical Switch Bar, 630, 36"



00516



00517



00518



00519



00525







00527

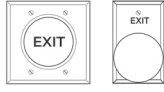
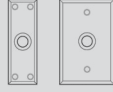

00528

Exit Switches

Series	410	420	430	440	450	EP499
						
Type	Push Button	Push Button	Push Button	Push Button	Push Button	Push Button
Button	Narrow	Square	1½" Mushroom	2¾" Mushroom	Vandal Round	Hazardous Mushroom
Faceplate	Stainless Steel	Stainless Steel	Stainless Steel	Stainless Steel	¼" Aluminum	-----
Models	Momentary, Electronic Timer, Pneumatic Timer, Alternate Action	Momentary, Electronic Timer, Pneumatic Timer, Alternate Action	Momentary, Latching, Alternate Action	Momentary, Alternate Action	Momentary, Pneumatic Timer, Alternate Action	Momentary
Size	Narrow	Single Gang	Single Gang	Single Gang, Double Gang	Narrow, Single Gang	Double Gang
Contact	SPDT, DPDT, DPST	SPDT, DPDT, DPST	SPST, DPST	SPST, DPST	SPDT, DPST	DPST
Finishes	630, 629, 606, 605, 613, 626, 625	630, 629, 606, 605, 613, 626, 625	630, 629, 606, 605, 613, 626, 625	630, 629, 606, 605, 613, 626, 625	628	Black
UL	UL294	UL294	UL294	-----	-----	UL Classified
Warranty	5 Year	5 Year	5 Year	5 Year	5 Year	5 Year
Buy American	Yes	Yes	Yes	Yes	Yes	-----

Popular Configurations

- 422U** Single Gang, Momentary (MO), SPDT, 630
- 423MU** Single Gang, Electronic Timer, Fixed (30 seconds), DPDT, 630
- 423PU** Single Gang, Pneumatic Timer, Adjustable (1-45 seconds), DPST, 630
- 423U** Single Gang, Electronic Timer, Adjustable (1-60 seconds), DPDT, 630
- 432KUR** Single Gang, Momentary (MO) Latching w/ Key Reset, DPST, 630, Red Button
- 452V** Single Gang, Momentary (MO), 628
- 413NU** Narrow, Electronic Timer, Adjustable (1-60 seconds), DPDT, 630
- 412NU** Narrow, Momentary (MO), SPDT, 630
- 413MNU** Narrow, Electronic Timer, Fixed (30 seconds), DPDT, 630
- EP499** Explosion Proof, Green Button, Momentary (MO), SPDT
- 424U** Single Gang, Momentary (MO), DPDT, 630
- 453PV** Single Gang, Pneumatic Timer, Adjustable, 628



412NU

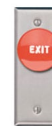

432CNU



452NV



422U



432KLDUR



452V



442U



EP499



EP499-R

Exit Sensors

Series	460	470	MD-31D
			
Type	Capacitive	Active IR	Request-to-Exit PIR
Activation	Touch	No Touch Wave	Motion
Faceplate	Stainless Steel	Stainless Steel	-----
Models	Timer and Alternate Action	Momentary, Momentary and Manual Override	Electronic Timer
Dual Voltage	Auto-Sensing	Field Selectable	Auto-Sensing
Finishes	630	630	White, Black
UL	-----	-----	UL294
Warranty	5 Year	5 Year	5 Year
Buy American	Yes	-----	-----



463NU



463U



474U



474DU



474MU



MD-31DB





MD-31DOW

Popular Configurations

- 463U** Single Gang, Capacitive Touch Sensor, 630
- 474U** Single Gang, No Touch Active IR Sensor, SPDT, 630
- MD-31DOW** Request-To-Exit PIR Motion Sensor, White
- MD-31DB** Request-To-Exit PIR Motion Sensor, Black
- 463NU** Narrow, Capacitive Touch Sensor, 630
- 474DU** Double Gang, No Touch Active IR Sensor, SPDT, 630
- 474MU** Single Gang, No Touch Active IR Sensor with Manual Override, SPDT, 630

Emergency Door Releases

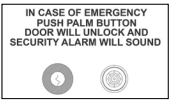
Series	491	492	EP493	APB1000A
				
Type	Release Station	Release Station	Release Station	Access Panel
Activation	Break Glass	Pull	Hazardous Pull	Mushroom Push
Siren	Yes	Yes	-----	Yes
Reset	Replace Glass	Replace Glass	Replace Glass	Key Reset
Replacement Glass	Two Pieces Included	Two Pieces Included	Two Pieces Included	-----
Finishes	Blue	Blue	Blue	Black
UL	UL38	UL38	UL Classified	-----
Warranty	5 Year	5 Year	5 Year	5 Year
Buy American	Yes	Yes	Yes	Yes

Popular Configurations

- 491** Emergency Break Glass Station
- 492** Emergency Pull Station
- 492WP** Emergency Pull Station, Weatherized
- APB1000A** Emergency Access Panel
- EP493** Explosion Proof Emergency Pull Station



491



492



EP493



APB1000A

ADA CONTROLS

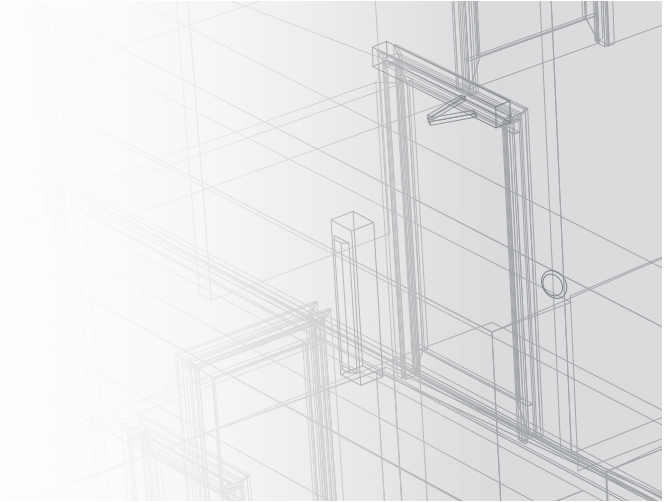

SDC's line of ADA Controls are designed to maximize public door accessibility for the Americans with Disabilities Act (ADA) Title III applications. Our product focus is on the section of the law - Title III - that addresses Public Accommodations and is intended to guarantee equality for those who are physically

handicapped or disabled. Included are low energy swing door operators, push plates, actuators and touch panels, and bollard posts. They all provide our latest and most convenient features to provide safe access for ADA applications and code compliance.



Low Energy Operators



Push Plates & Panels



Bollards

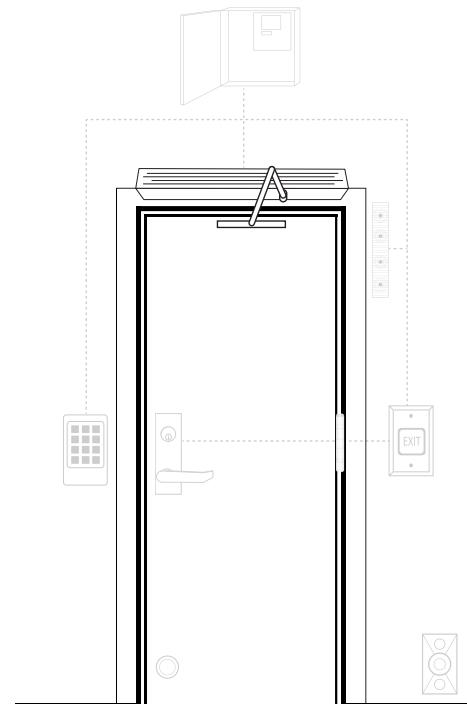

Low Energy Operators

AUTO Series

HANDS FREE
CONVENIENCE &
ADA COMPLIANCE

AUTOS One Drive Unit, Single Door Operation

AUTOP Two Drive Units, Double Door Operation

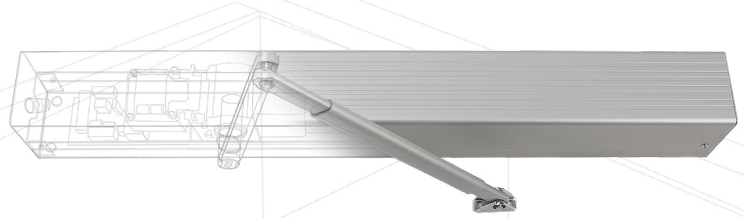

SDC EntryControl™

UL 325, UL 10C
2 Year Warranty
Buy American

Single Technician Installation

Pre-drilled mounting holes, slotted back plate and **fixed mounting bolt** for hanging drive unit while installing allows for easy, single technical installs.

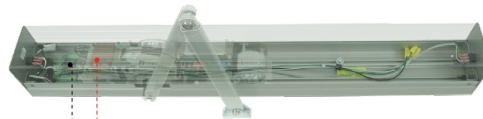
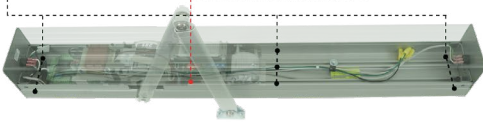

1 Amp+, 24VDC Built-In Power Supply

Powers and controls magnetic locks, electric strikes and motorized latch retraction for true integration with popular access & egress control hardware.

Dual vestibule control of multiple operators.

- Built-in 1 amp+ power supply
- Single button, self-tuning setup
- Onboard locking sequencing
- Extremely quiet operation
- Momentary back pressure relief
- Hold open feature



AUTOS136V



AUTOS236V

Popular Configurations



- AUTOS136V** Single, Push Arm, 20mm Spindle, 36" Door, 39" Housing, 628
- AUTOS236V** Single, Pull Arm, 20mm Spindle, 36" Door, 39" Housing, 628
- AUTOS136Y** Single, Push Arm, 20mm Spindle, 36" Door, 39" Housing, 335
- AUTOS142V** Single, Push Arm, 20mm Spindle, 42" Door, 45" Housing, 628
- AUTOS336V** Single, Arm Kit, 20mm Spindles, 36" Door, 39" Housing, 628
- AUTOS148V** Single, Push Arm, 20mm Spindle, 48" Door, 51" Housing, 628
- AUTOP172V** Double, Push Arms, 20mm Spindles, 72" Door, 75" Housing, 628
- AUTOS236Y** Single, Pull Arm, 20mm Spindle, 36" Door, 39" Housing, 335
- AUTOP172Y** Double, Push Arms, 20mm Spindles, 72" Door, 75" Housing, 335
- AUTOS172V** Single, Push Arm, 20mm Spindle, 72" Door, 75" Housing, 628
- AUTOP272V** Double, Pull Arm, 20mm Spindle, 72" Door, 75" Housing, 628
- AUTOP184V** Double, Push Arms, 20mm Spindles, 84" Door, 87" Housing, 628
- AUTOP472V** Double, Double Egress, 80mm and 20mm Spindles, 72" Door, 75" Housing, 628

Accessories

- AUTO-IR36Y** Presence Sensor, 36", 335
- AUTO-IR48Y** Presence Sensor, 48", 335
- SP20** Optional/Replacement Spindle, 20mm
- SP35** Optional/Replacement Spindle, 35mm
- SP50** Optional/Replacement Spindle, 50mm
- SP80** Optional/Replacement Spindle, 80mm
- AUTO-KS** Single Gang Remote Key Lock Switch, 630
- AUTO-KSN** Narrow Remote Key Lock Switch, 630
- AUTO-RKR** Narrow Remote Rocker Switch, 630
- AUTO-PROG** Handheld Programmer

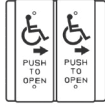

Push Plate & Panels

Series	480	480V	480AA
			
Type	Push Plate	Vestibule Push Plate	Push Panel
Application	Handicap Access, Automatic Door Activation, Request-to-Exit	Handicap Access, Automatic Door Activation, Request-to-Exit	Handicap Access, Automatic Door Activation, Request-to-Exit
Mount	Recessed, Surface Box, Bollard	Recessed, Surface Box, Bollard	Surface Wall or Bollard
Faceplate	Stainless Steel	Stainless Steel	Aluminum
Size	Narrow, Single Gang, 4½" Square, 4½" Round, 6" Square, 6" Round	4½" Square	36" x 6"
Contact	SDPT or DPDT	SPDT	SDPT or DPDT
Activation	Entire Plate Surface	Entire Plate Surface	Entire Panel Surface
Finishes	630	630	628
UL	UL1054	UL1054	UL1054
Warranty	5 Year	5 Year	5 Year
Buy American	Yes	Yes	Yes



Narrow



Single Gang



4½" & 6" Square



4½" & 6" Round



Vestibule



36" x 6"
Push Panel

Popular Configurations

- 482A4U** 4½" Square Push Plate, SPDT, ♿ PUSH TO OPEN, 630
- 484A4U** 4½" Square Push Plate, DPDT, ♿ PUSH TO OPEN, 630
- 482A2U** Single Gang Push Plate, SPDT, ♿ PUSH TO OPEN, 630
- 482AA36V** 36" x 6" Push Panel, SPDT, ♿ PUSH TO OPEN, 628
- 484AA36V** 36" x 6" Push Panel, DPDT, ♿ PUSH TO OPEN, 628
- 482A1U** Narrow Push Plate, SPDT, ♿ PUSH TO OPEN, 630
- 48202U** Single Gang Push Plate, SPDT, PUSH TO OPEN, 630
- 48404RU** 4½" Round Push Plate, DPDT, PUSH TO OPEN, 630
- 482A4RU** 4½" Round Push Plate, SPDT, ♿ PUSH TO OPEN, 630
- 48204U** 4½" Square Push Plate, DPDT, PUSH TO OPEN, 630
- 48201U** Narrow Push Plate, SPDT, PUSH TO OPEN, 630
- 482A6U** 6" Square Push Plate, SPDT, ♿ PUSH TO OPEN, 630

Wireless Push Plate Kits

- 482S-KIT** Wireless Push Plate Kit, Square Plates
- 482R-KIT** Wireless Push Plate Kit, Round Plates
- 482S-CBCKIT** Wireless Push Plate Kit, CBC High-Low Compliant Plates



Wireless Transmitters & Receivers

- 400RC433** 433MHz One Channel Receiver
- 400W1-433** 433MHz Micro Transmitter

Common Mounting Boxes

- 480-1SB** Narrow Surface Box, 1¾" x 4⅞" x 1¾"
- 480-2SB** Single Gang Surface Box, 2¾" x 4½" x 1⅞"
- 480-4SSB** 4½" and 6" Square Surface Box, 4½" x 4½" x 1¾"

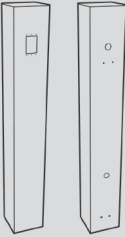
Bollards

Series	BP	CBC
		
Type	Square Post	CBC Post
Post	1/8" Aluminum	1/8" Aluminum
Mount	Surface, In-Ground	Surface
Push Plate Prep	Narrow, Single Gang, Double Gang	-----
Push Panel Prep	Yes	-----
Push Plates Included	-----	Yes
Removable Cap	Black HDPE Mortise	Black HDPE Mortise
Transmitter Mount	Yes	Yes
Finishes	628, 710	628
UL	-----	-----
Warranty	5 Year	5 Year
Buy American	Yes	Yes



BP



CBC482A4U

Popular Configurations

- BPS6SV** Surface Mount Bollard, 6" x 6" x 42", Single Gang Switch Prep, 628
- BPS6DV** Surface Mount Bollard, 6" x 6" x 42", Double Gang Switch Prep, 628
- BPS6PV** Surface Mount Bollard, 6" x 6" x 42", Push Panel Prep, 628
- CBC482A4U** CBC Compliant Surface Mount Bollard, 6" x 6" x 42", Push Plates Included, 628
- BPG6SV** In-Ground Bollard, 6" x 6" x 54", Single Gang Switch Prep, 628
- BPG6DV** In-Ground Bollard, 6" x 6" x 54", Double Gang Switch Prep, 628
- BPG6PV** In-Ground Bollard, 6" x 6" x 54", Push Panel Prep, 628
- BPS6SX** Surface Mount Bollard, 6" x 6" x 42", Single Gang Switch Prep, 710
- BPS6PX** Surface Mount Bollard, 6" x 6" x 42", Push Panel Prep, 710
- BPS6AV** Surface Mount Bollard, 6" x 6" x 42", Narrow Switch Prep, 628
- BPG6SX** In-Ground Bollard, 6" x 6" x 54", Single Gang Switch Prep, 710
- BPS6DX** In-Ground Bollard, 6" x 6" x 54", Double Gang Switch Prep, 710

POWER TRANSFER DEVICES

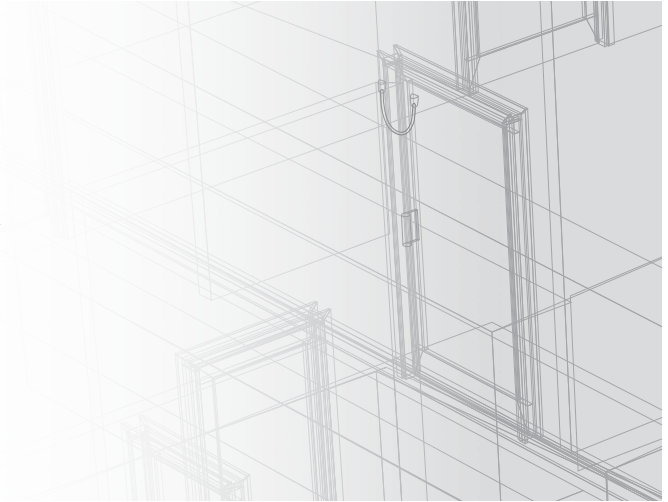

From frame to door, SDC's power transfer devices provide secure, concealed or vandal-resistant means to transfer power and monitoring signals to doors equipped with electric locks and devices. SDC offers a range of

proven power transfer devices including concealed mortise devices, wired door transfer hinges and wireless power transfer devices – all UL listed for 3hr fire rated doors.

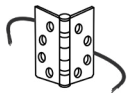

Hinges

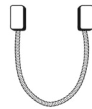

Loops

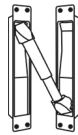

Mortise Transfer

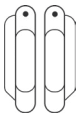





Wireless Transfer

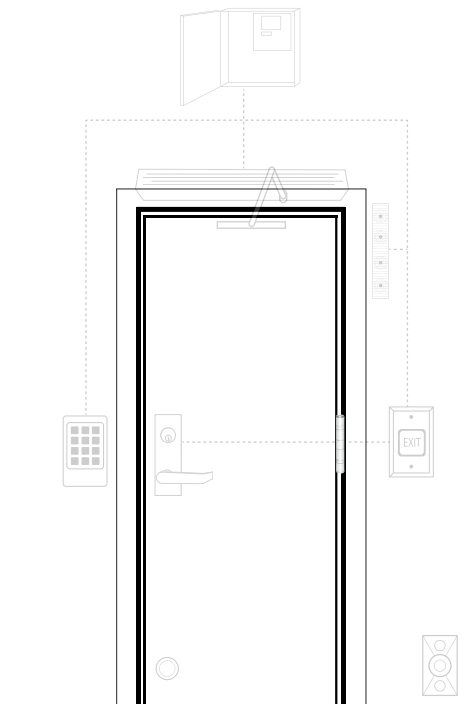

Laser Guided Wire Raceway Drill Kits

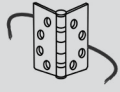

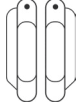
Power Transfer Devices

Series	PTH	PT	PTM	WPT	7000-DGK
					
Type	Electrified Hinge	Loop	Electrified Mortise	Wireless	Door Coring Kit
Application	Standard Weight, 5 Knuckle	Stainless Steel, Armored Flex	Heavy Cast Steel	Radio Frequency (RF) Transmission	Laser Guided Wire Raceway Drill Fixture
Mount	Mortise	Surface, Mortise	Mortise	Mortise	-----
Conductors	Four, Six, Ten	-----	Two, Ten	-----	-----
Wire Replacement Warranty	Yes	-----	-----	-----	-----
Monitoring	Optional	-----	-----	Standard	-----
Finishes	626	628	Aluminum, Bronze	Black	-----
UL	UL10C, ULC-S104	UL10C	UL10C	UL1034, UL10C	-----
Warranty	5 Year	5 Year	5 Year	5 Year	5 Year
Buy American	-----	-----	-----	-----	Yes



PT-2U



PT-3V



PT-5



PTH-4Q



PTM-2AL



WPT



7000-DGK

Popular Configurations

- PTH-4Q** Four Conductor Hinge, 626
- PT-2U** Surface Loop, Plastic End Caps
- PT-3V** Surface Loop, Aluminum Box End Caps
- PTH-2+4Q** Six Conductor Hinge, 626
- PT-5** Concealed Mortise Loop
- PT-3/8V** Surface Loop, Aluminum Box End Caps, 3/8" ID

- PTM-10AL** Ten Conductor Mortise Device, Aluminum Powder Coat
- PTH-10Q** Ten Conductor Hinge, 626
- PTH-4QDPS** Four Conductor Hinge, 626, DPS
- PTH-2+4QDPS** Six Conductor Hinge, 626, DPS
- 7000-DGK** Laser Guided Wire Raceway Drill Fixture Kit
- WPT** Wireless Power Transfer Device

POWER SUPPLY & DOOR CONTROLS

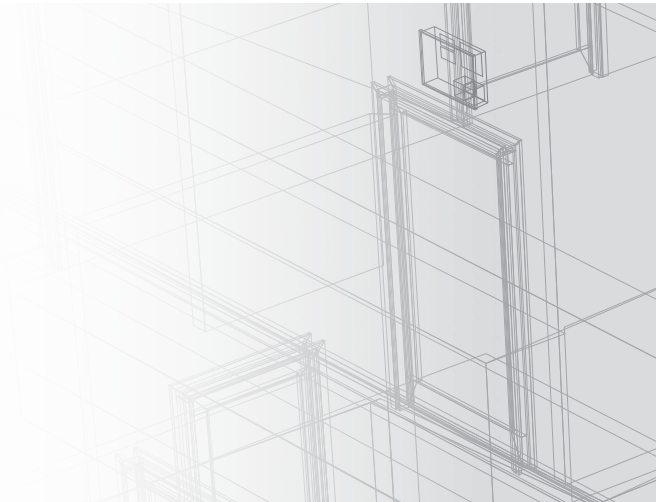

SDC access control power supplies have been developed specifically to support access controls and electric locking hardware with clean, consistent power. Combined with SDC's door controllers, there's a convenient and reliable way to wire, set dip switches and install reliable power for virtually any door control

application. The circuitry design is ideal for the inductive loads generated by access control hardware for high performance and longevity. The modular design is built around several different control modules to meet the most demanding component interface and control logic requirements.

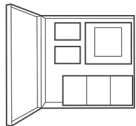

Power Controllers

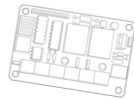

Door Controllers

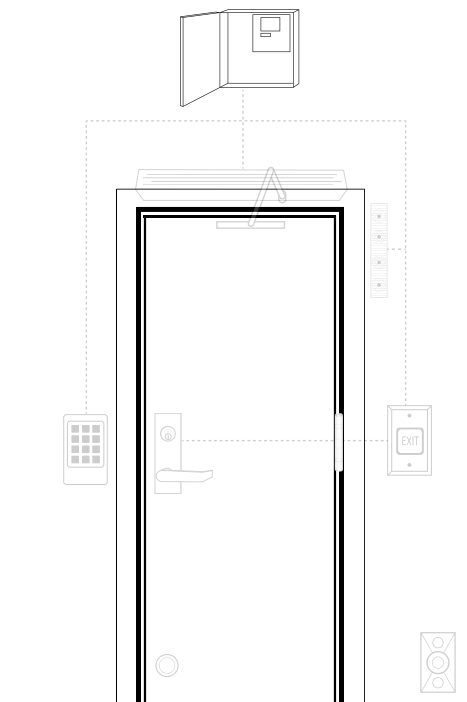

Power Controllers

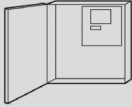
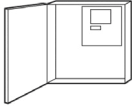
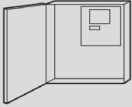
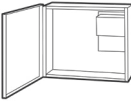
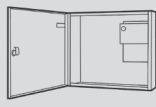
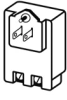
Series	602	631	632	634	636	TR
						
Type	Hybrid Controller	Hybrid Controller	Hybrid Controller	Hybrid Controller	Hybrid Controller	Transformer
Hybrid Controller	Switching & Linear	Switching & Linear	Switching & Linear	Switching & Linear	Switching & Linear	-----
Regulated & Filtered	Yes	Yes	Yes	Yes	Yes	Yes
DC Output	1 Amp	1.5 Amp	2 Amp	4 Amp	6 Amp	1 Amp
Small Cabinet	602RF	631RF	632RF	-----	-----	-----
Large Cabinet	602RFA	631RFA	632RFA	634RFA	636RFA	-----
Less Cabinet	602RFL	631RFL	632RFL	-----	-----	-----
Fire/Emergency Release Input	Yes	Yes	Yes	Yes	Yes	-----
Isolated Battery Charging Circuit	Yes	Yes	Yes	Yes	Yes	-----
Low Battery Disconnect	Yes	Yes	Yes	Yes	Yes	-----
Dual Voltage	Field Selectable	Field Selectable	Field Selectable	Field Selectable	Field Selectable	-----
UL	UL294, UL603, ULC-S318	UL294, UL603, ULC-S318, UL864, UL1481	UL1012, UL2043	UL1012, UL2043	UL1012, UL2043	-----
Warranty	5 Year	5 Year	5 Year	5 Year	5 Year	3 Year
Buy American	Yes	Yes	Yes	Yes	Yes	-----



602RF



631RF



632RF



634RFA



636RFA



TR12



TR24

Popular Configurations

- 602RF** 1 Amp DC Hybrid Power, Cabinet
- 632RF** 2 Amp DC Hybrid Power, Cabinet
- 631RF** 1.5 Amp DC Hybrid Power, Cabinet
- 602RFKFL** 1 Amp DC Hybrid Power, Cabinet, Key Lock Cover
- 634RFA** 4 Amp DC Hybrid Power, Cabinet
- 602RF220** 1 Amp DC Hybrid Power, Cabinet, 230 VAC, 50/60 Hz
- TR12** Regulated 12 VDC Plug-In Power Transformer, 1 Amp
- TR24** Regulated 24 VDC Plug-In Power Transformer, 1 Amp
- 631RFA** 1.5 Amp DC Hybrid Power, Large Cabinet
- 632RFKFL** 2 Amp DC Hybrid Power, Cabinet, Key Lock Cover
- 602RFL** 1 Amp DC Hybrid Power, Less Cabinet
- 631RFUR1** 1.5 Amp DC Hybrid Power, Cabinet, Microprocessor Door Controller

Backup Batteries

- RB12V4** 12V / 5Ah Battery
- RB12V4-2** 12V / 5Ah Battery Pack, Quantity 2
- RB12V7** 12V / 7Ah Battery
- RB12V7-2** 12V / 7Ah Battery Pack, Quantity 2

Utilize SDC's online calculators to calculate any discharge time.



SDCSEC.COM/CALCULATORS

Microprocessor-Based Door Controllers

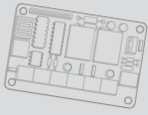
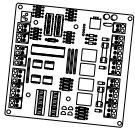
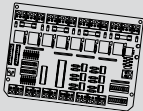
Series	UR-1	UR2-4	UR4-8
			
Application	Relay configurable control for one or two locks (trigger, timed, latching or sequenced)	Interlocks, mantraps and communicating bathroom (two doors)	Interlocks, mantraps and communicating bathroom (four doors)
Stations	1	2	4
Inputs (Per Station)	(2) Relay, N/O	(4) Relay, N/O or N/C (4) Auxiliary, N/O	(8) Relay, N/O or N/C (4) Auxiliary, N/O
Outputs	(2) SPDT, Wet or Dry	(2) SPDT, Fused, Wet or Dry (2) SDPT, Unfused, Wet or Dry	(4) SPDT, Fused, Wet or Dry (4) SDPT, Unfused, Wet or Dry
UL	-----	-----	-----
Warranty	5 Year	5 Year	5 Year
Buy American	Yes	Yes	Yes



UR-1



UR2-4

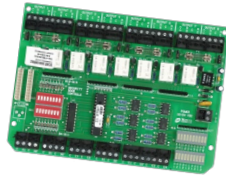

UR4-8

Popular Configurations

- UR2-4** Universal Microprocessor-Based Controller, Four Relays
- UR4-8** Universal Microprocessor-Based Controller, Eight Relays
- UR-1** Universal Microprocessor-Based Controller, Two Relays

Communicating Bathroom Packages

SDC's CBP series communicating bathroom control packages combine CB series control switches into pre-spec'd mortise, cylindrical or electromagnetic lock system solutions. **One part number covers it all.**

Every shared bathroom package includes a riser diagram, components list, method of operation and wiring diagram to help you determine the materials and installation costs to complete your project bid.

PACKAGE COMPONENTS

- (2) Electrified locking devices with built-in latch status or door position status (mortise, cylindrical or electromagnetic)
- (1) System activation push button switch
- (2) Emergency access push button switches
- (1) 1.5 Amp power supply with universal relay
- (2) Power transfer hinges

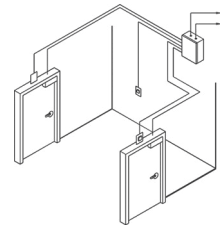

MORTISE LOCK PACKAGES

CBP-ME-78 Solenoid controlled locksets with eclipse trim

CBP-MG-78 Solenoid controlled locksets with galaxy trim

CYLINDRICAL LOCK PACKAGES

CBP-CE-72 Solenoid controlled locksets with eclipse trim

CBP-CG-72 Solenoid controlled locksets with galaxy trim

ELECTROMAGNETIC LOCK PACKAGES

CBP-EM-81 650lb holding force

CBP-EM-71 1200lb holding force

CBP-EM-11 1650lb holding force

SDCSEC.COM/SYSTEMDESIGN

Door Controllers

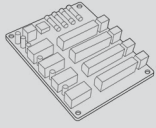
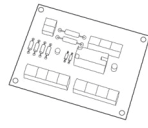
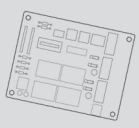
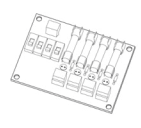
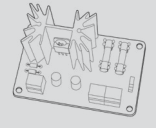
Series	CR4	ACM-1	EMC	FB-4	12VR
					
Description	Four station control relays	Six input control relays	Dual channel exit device sequencers	Four output power distribution modules	Voltage power converters
Application	Individual control of four locks	Control one lock with up to six activation devices	Sequence electrified panic device and operator for single or pair of doors	Distribute a single voltage output to four devices	Convert 24 VDC to regulated 12 VDC output
Inputs	(4) N/O, Dry	(3) N/O, Dry (3) N/C, Dry	(2) N/O, Dry	(1) Power, 12/24 VDC	(1) Power, 24 VDC
Outputs	(4) SPDT, Fused, Wet or Dry (4) SPDT, Unfused, Wet or Dry	(1) SPDT, Wet (1) SPDT, Dry	(4) N/O, Dry	(4) Fused Class 2, On/Off, 12/24VDC (Matches input)	(1) Fused Class 2, 12 VDC (1) Fused Class 2, 24 VDC
UL	----	----	----	----	----
Warranty	5 Year	5 Year	5 Year	5 Year	5 Year
Buy American	Yes	Yes	Yes	Yes	Yes

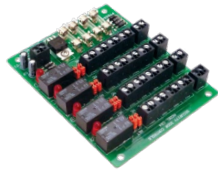

CR-4



ACM-1



EMC



FB-4



12VR

Popular Configurations

- CR4** Four Station Control Relay
- FB-4** Four Output Power Distribution Module
- EMC** Dual Channel Exit Device Sequencer
- ACM-1** Six Input Control Relay
- 12VR** Voltage Power Converter

System Design Services

Ever wish you could save time and money when programming multidoor projects? Troubleshooting product conflicts frustrating you? Are system maintenance headaches eating into your profit? SDC's low cost comprehensive services are available when you purchase SDC locks, controller and power supply for door opening applications from your distributor.

- Interlocks
- Mantraps
- Communicating Bathroom
- Delayed Egress
- Authorized Personnel
- Custom Design

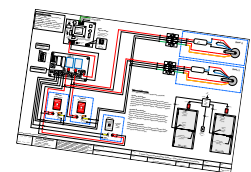

SDCSEC.COM/SYSTEMDESIGN

REMOTE CONTROLS & ANNUNCIATORS



SDC's line of remote controls and annunciators are designed to meet the demands of varying control and monitoring applications without PC-based access control

capability. They provide flexible solutions for central monitoring and control of openings in a facility as well as audible and/or visual status supervision and notification.

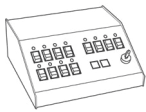

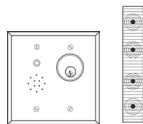

Remote Control
Consoles

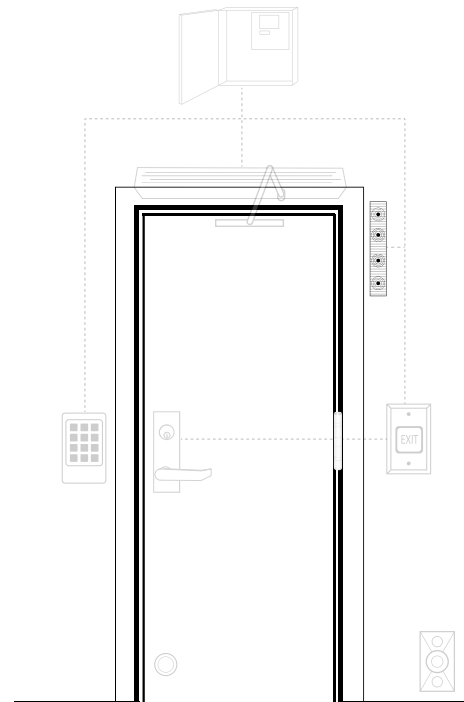

Door Prop Alarms
& Annunciators



Remote Control Consoles

Series	DT	D15
		
Type	Mini Desktop	Concealed Desk Switch
Stations	Up to 2	1
Activation	Push	Push or Toggle
Models	Momentary (MO), Alternate Action (AA)	Momentary (MO), Alternate Action (AA)
LED Indicator	Yes	-----
Finishes	Gray	White, Black
UL	-----	-----
Warranty	5 Year	5 Year
Buy American	Yes	Yes



DTMO-1



DTMO-2



D15-1



D15-2



D15-2-3







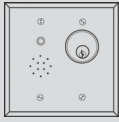

D15-3

Popular Configurations

D15-2	Concealed, Momentary (MO) Push Button
D15-2-3	Concealed, Momentary (MO) Push Button and Alternate Action (On/Off) Toggle Switch
DTMO-2	Mini Desktop, Two Momentary (MO) Switches
DTMO-1	Mini Desktop, One Momentary (MO) Switch
DTMOMA-2	Mini Desktop, One Momentary (MO) Switch, One Alternate Action (On/Off) Switch
D15-1	Concealed, Alternate Action (On/Off) Push Button
D15-3	Concealed, Alternate Action (On/Off) Toggle Switch
DTMA-2	Mini Desktop, Two Alternate Action (On/Off) Switches
DTMA-1	Mini Desktop, One Alternate Action (On/Off) Switch

Door Prop Alarms & Annunciators

Series	EA	EA100	400-L	400-SN	400-RMB
					
Trademark	-----	ExitAnnunciator®	-----	-----	-----
Type	Alarm	Annunciator	Annunciator	Alarm	Annunciator
Indicator	LED & Siren	LED	LED	Siren	Buzzer
Faceplate	Aluminum	-----	Stainless Steel	Stainless Steel	Stainless Steel
Siren	85 dB Piezo	-----	-----	90 dB	24 mA
Reset	Automatic or Manual	-----	-----	-----	-----
Size	Single Gang, Double Gang	Narrow	Narrow, Single Gang	Narrow, Single Gang	Narrow, Single Gang
Dual Voltage	Field Selectable	Field Selectable	-----	Auto-Sensing	Auto-Sensing
Finishes	628	-----	628	628	628
UL	-----	-----	-----	-----	-----
Warranty	5 Year	5 Year	5 Year	5 Year	5 Year
Buy American	Yes	Yes	Yes	Yes	Yes



EA-SN



EA-728V



EA-708V



EA-100



400U-LT1



400U-LT1



400U-L2



400U-L3

Popular Configurations

- 400U-L2** Single Gang Visual Monitoring Station, One Green & One Red LED
- EA-SN** Single Gang Door Prop Alarm
- 400U-RMB** Single Gang Buzzer Alarm Station
- 400U-SN** Single Gang Siren Alarm Station
- EA100** Multi-Mode Visual Annunciator
- EA-708V** Double Gang Door Prop Alarm, Mortise Key Cylinder Reset/Bypass Prep
- EA-728V** Double Gang Door Prop Alarm, Keylock Reset/Bypass
- 400U-LT1** Single Gang Visual Monitoring Station, One Tri-Color LED
- 400U-SN** Narrow Siren Alarm Station
- 400U-L2** Narrow Visual Monitoring Station, One Green & One Red LED
- 400U-RMB** Narrow Buzzer Alarm Station
- 400U-LT2** Single Gang Visual Monitoring Station, One Green & One Red LED



400U-SN



400NU-SN



400U-RMB



400NU-RMB

ACCESSORIES & MISC

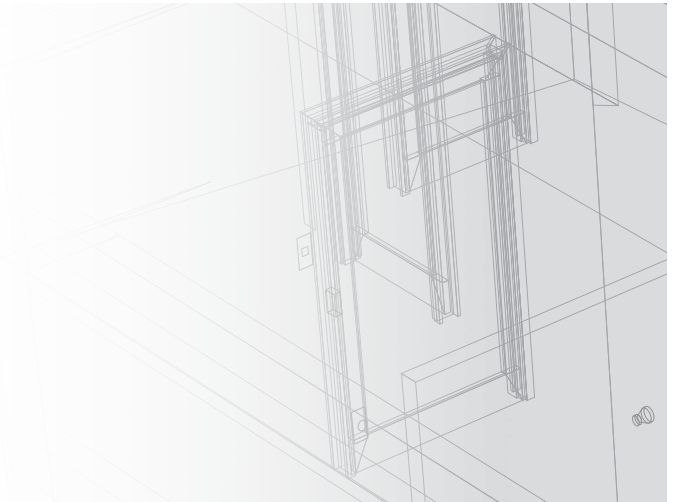

From wireless remote controls to durable door holder and release devices, to door position sensors, timers; from concealed contact to universal mounting enclosure - there's an SDC accessory to complement

or enhance almost any access or egress component. In addition, we offer specialized controls and packages for communicating bathrooms.



Electromagnetic Door Holders

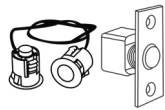

Door Position Monitoring

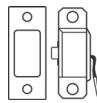

Latch & Deadbolt Monitoring Strikes



Wireless Transmitters & Receivers



Communicating Bathroom Controls

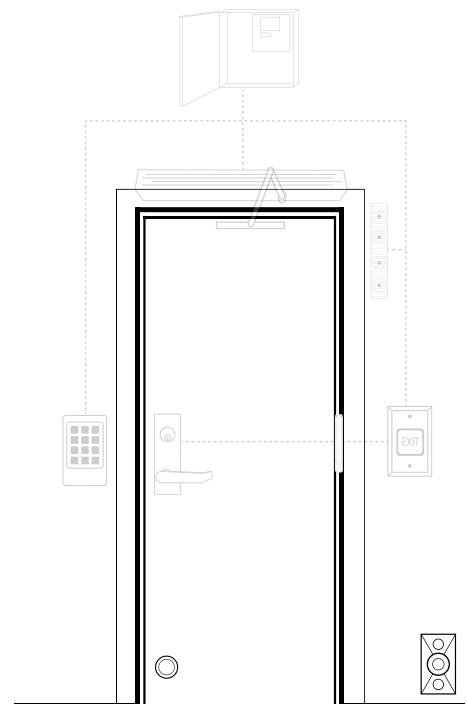

Electromagnetic Door Holders

EH Series

ELECTROMAGNETIC DOOR HOLDER & RELEASING DEVICES

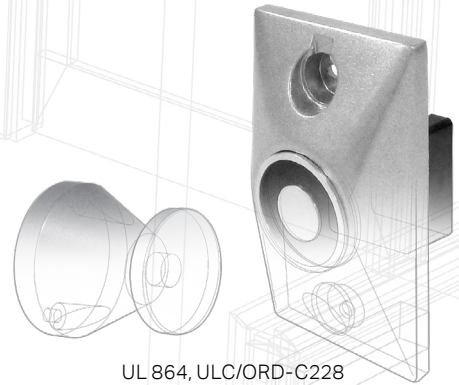

UL 864, ULC/ORD-C228
5 Year Warranty
Buy American

Popular Configurations

- EH301224A** Surface Mount, 12/24VAC/DC, Chrome Powder Coat
- EH3024120A** Surface Mount, 24VAC/DC, 120VAC, Chrome Powder Coat
- EH201224A** Semi-Flush Mount, 12/24VAC/DC, Chrome Powder Coat
- EH2024120A** Semi-Flush Mount, 24VAC/DC, 120VAC, Chrome Powder Coat
- EH101224A** Flush Mount, 12/24VAC/DC, Chrome Powder Coat
- EH1024120A** Flush Mount, 24VAC/DC, 120VAC, Chrome Powder Coat
- EH401224A** Floor Mount Single, 12/24VAC/DC, Chrome Powder Coat
- EH2024220A** Semi-Flush Mount, 24VAC/DC, 220VAC, Chrome Powder Coat
- EH1024220A** Flush Mount, 24VAC/DC, 220VAC, Chrome Powder Coat
- EH3024220A** Surface Mount, 24VAC/DC, 220VAC, Chrome Powder Coat
- EH421224A** Floor Mount Double, 12/24VAC/DC, Chrome Powder Coat
- EH1024120C** Flush Mount, 24VAC/DC, 120VAC, Black Powder Coat



EH101224A



EH201224A



EH301224A



EH401224A



EH421224A

Extension Rods



- EHR1A** Extension Rod, 1", Chrome
- EHR2A** Extension Rod, 2", Chrome
- EHR3A** Extension Rod, 3", Chrome
- EHR4A** Extension Rod, 4", Chrome
- EHR5A** Extension Rod, 5", Chrome
- EHR15A** Extension Rod, 1½", Chrome
- EHR02A** Extension Rod, ½", Chrome

Adjustable Extension Rods



- EHRA15A** Adjustable Extension Rod, 1½", Chrome
- EHRA15B** Adjustable Extension Rod, 1½", Black
- EHRA4A** Adjustable Extension Rod, 4", Chrome
- EHRA4B** Adjustable Extension Rod, 4", Black



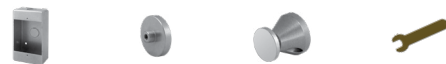

Replacement Parts & Installation Tools

- EHBBA** Surface Back Box, 2⁵/₃₂" x 4⁷/₈" x 1½", Chrome
- EHBBB** Surface Back Box, 2⁵/₃₂" x 4⁷/₈" x 1½", Black
- EHCPA** Catch Plate, Chrome Powder Coat
- EHCPB** Catch Plate, Black Powder Coat
- EHSBAA** Catch Plate Assembly, Chrome Powder Coat
- EHSBAA** Catch Plate Assembly, Black Powder Coat
- EHW** Extension Wrench

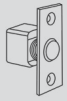

For a complete list of all available electromagnetic door holder accessories, please refer to the product datasheet.

Door Position Status Monitoring

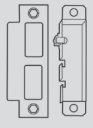
Series	DPS-11	MC-4	MC-4M	MC-7	MS
					
Type	Electromechanical ball	Magnetic contact	Magnetic contact	Magnetic contact	Magnetic contact
Key Feature	Adjustable for wide door gap	UL 10C fire rating, 3hr	Concealed design for vandal resistance	Biased for high security monitoring	Concealed design for vandal resistance
UL	-----	UL10C	-----	-----	-----
Warranty	5 Year	5 Year	5 Year	5 Year	5 Year
Buy American	Yes	Yes	Yes	Yes	Yes

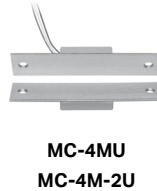

Popular Configurations

- MC-4** DPS Monitoring, Recessed Magnetic Contact, SPDT
- MC-7** DPS Monitoring, Biased High Security Recessed Magnetic Contact, SPDT
- MC-4MU** DPS Monitoring, Concealed Magnetic Contact, SPDT
- DPS-11** DPS Monitoring, Adjustable Ball Switch, SPDT
- MC-4PAK** DPS Monitoring, Recessed Magnetic Contact Pack, SPDT, Qty 10
- MS-18** DPS Monitoring Strike, Mortise Lock Deadbolt, SPDT
- MS-12** DPS Monitoring Strike, Cylindrical Lock or Tubular Deadbolt, 2¾" Strike, SPDT
- MS-16** DPS Monitoring Strike, Mortise Lock Latchbolt, SPDT
- MS-18D** DPS Monitoring Strike, Mortise Lock Deadbolt, DPDT
- MC-4M-2U** DPS Monitoring, Concealed Magnetic Contact, DPDT
- DPS-11-2** DPS Monitoring, Adjustable Ball Switch, SPDT (2)
- MS-14** DPS Monitoring Strike, Cylindrical Lock, 4¾" Strike, SPDT

Miscellaneous

WRC Series

TWO CHANNEL WIRELESS TRANSMITTERS & RECEIVERS

3 Year Warranty

- WRC-R2** Wireless Receiver, Two Channel, 24VDC
- WRC-R2-12** Wireless Receiver, Two Channel, 12VDC
- WRC-2B** Wireless Transmitter, Two Button Pendant



WRC-2B



WRC-R2
WRC-R2-12

CB Series

COMMUNICATING BATHROOM CONTROL SWITCHES

5 Year Warranty

Buy American

- CB401-AU** Comm Bath Push Button, System Activation, Alternate Action (AA) On/Off, 630
- CB402-AU** Comm Bath Push Button, System Activation, Momentary (MO), 630
- CB401-B** Comm Bath Push Button, Emergency Access, Alternate Action (AA) On/Off, Red
- CB402-B** Comm Bath Push Button, Emergency Access, Momentary (MO), Red
- CB701** Comm Bath Key Switch, Emergency Access, Alternate Action (AA) On/Off, Red
- CB702** Comm Bath Key Switch, Emergency Access, Momentary (MO), Red



CB401-AU
CB402-AU



CB401-B
CB402-B



CB701
CB702

[SEE PAGE 33 FOR COMMUNICATING BATHROOM PACKAGES](#)

CYL Series

KEY CYLINDERS

5 Year Warranty

Buy American

- CYL-6KAQ** Mortise Cylinder 6-Pin, 1 1/8" Length, Keyed Alike
- CYL-6KDK** Mortise Cylinder, 6-Pin, 1 1/8" Length, Keyed Different
- RIM-CYL-KA** Rim Cylinder, 6-Pin, Keyed Alike



CYL-6KAQ
CYL-6KDK



RIM-CYL-KA

COMPLETE COMPONENT CONSIDERATIONS

With a robust toolbox of over 35,000 SDC access & egress control components at your fingertips, you can assemble turnkey solutions to address both market-specific and application-specific requirements for almost any door opening imagined – while addressing a variety of factors, including:

- Level of Security
- Budget Restrictions
- Type of Door or Frame
- Life Safety Codes
- Aesthetics
- Retrofit or New Construction

BASIC COMPONENT CONSIDERATIONS FOR CONTROLLED DOOR SYSTEMS

- 1 LOCKING DEVICES
- 2 ACCESS CONTROLS
- 3 EGRESS CONTROLS
- 4 ADA CONTROLS
- 5 POWER TRANSFER DEVICES
- 6 POWER SUPPLY & DOOR CONTROLS
- 7 REMOTE CONTROLS & ANNUNCIATORS
- 8 ACCESSORIES & MISC

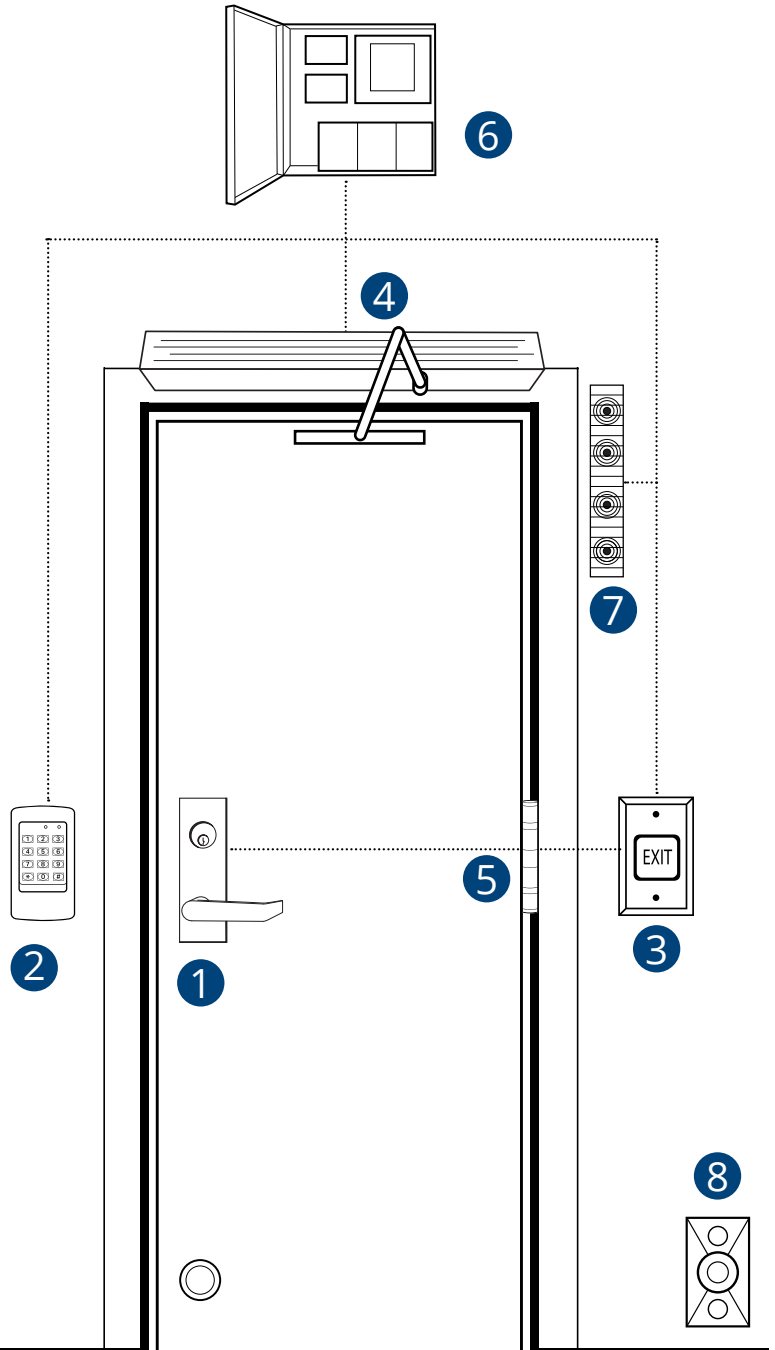

Components not to scale

1 LOCKING DEVICES

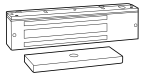

Electromagnetic Locks

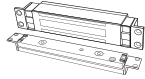

Electromagnetic Shear Locks

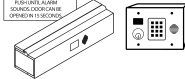

Delayed Egress Locks

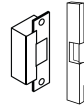

Electric Strikes



Electrified Locksets

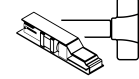

Exit Devices & Retrofit ELR Kits

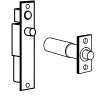

Electric Bolt Locks

2 ACCESS CONTROLS



IP-Based Controllers

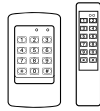

Keypads & Readers

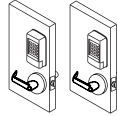

Standalone Locksets

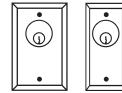

Key Switches

3 EGRESS CONTROLS



Egress Devices

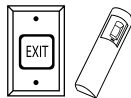

Exit Switches & Sensors



Emergency Door Releases

4 ADA CONTROLS

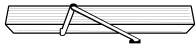

Low Energy Operators



Push Plates & Panels



Bollards

5 POWER TRANSFER DEVICES

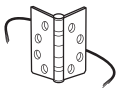

Hinges



Loops

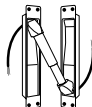

Mortise Transfer



Wireless Transfer

6 POWER SUPPLY & DOOR CONTROLS

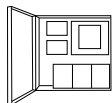

Power Controllers

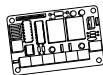

Door Controllers

7 REMOTE CONTROLS & ANNUNCIATORS



Remote Control Consoles



Door Prop Alarms & Annunciators

8 ACCESSORIES & MISC



Electromagnetic Door Holders

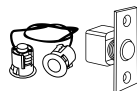

Door Position Monitoring



Latch & Deadbolt Monitoring Strikes



Wireless Transmitters & Receivers



Communicating Bathroom Switches

